

Encrypting A 7.88ghz Frequency Message Within A Chaotic Carrier by Optical Feedback

Ayser A. Hemed^{*1}, Thorsten Ackemann², Hani J. Kbashi³ and Baha T. Chead⁴

¹Department of Physics, college of education, Mustansiriyah University, Baghdad, IQ

²Photonics at University of Strathclyde, Glasgow, UK

³School of Engineering and Applied Science, AIPT, Aston University, Aston, UK.

⁴Department of Physics, college of Science, University of Baghdad, Baghdad, IQ

Emails:

1. aysyer.hemed@uomustansiriyah.edu.iq

2. thorsten.ackemann@strath.ac.uk

3. kbashihj@aston.ac.uk

4. bahatoama@yahoo.com

Abstract: A new laser system is suggested and experimentally verified as a chaotic transmitter for a secure optical communication system. The laser source kind is a distributed feedback with a peak wavelength 1310nm and maximum power 5mW. A doubly external cavity with 85cm of length is constructed via air.

Chaotic signal is achieved successfully after the laser reach of coherence collapse, with a very wide band spectrum (12GHz). This value is capable to increase subjecting to several parameters based on optical feedback (OFB) such as laser current operating level, beam focusing, polarization control, etc. In order to test a message hiding possibility, a frequency message is modulated directly into the laser, which is connected with the laser source using a bias tee. For the free running (solitary) semiconductor laser, the maximum available direct current modulation is: 3GHz/mA, while this value can be increased by this technique. This gives the possibility for very high modulation values and increasing data package volume that can send securely in the applications that requires immunity.

1. Modulation with Semiconductor Laser:

Direct modulation into semiconductor laser (SL) represents one technique for chaos generation (CG). Increasing transmission capacity (modulation within chaos carriers itself) represents a goal

* Corresponding Author



for wide band secure optical communications. Adding an external modulation to the pumping current (pump modulation) for a laser system as shown in figure 1, laser intensity chaotic instability may appear. External frequency modulation frequency needs to be normalized around laser relaxation oscillation frequency (ROF), so that nonlinear interaction between that frequency external modulation and later frequency may result in CG.

The frequency EM can also be added to the loss of the internal laser cavity, which is named as loss modulation. From the other hand, chaotic dynamics is typically observed through the quasi periodicity route to chaos linearly related to strength of frequency external modulation [1].

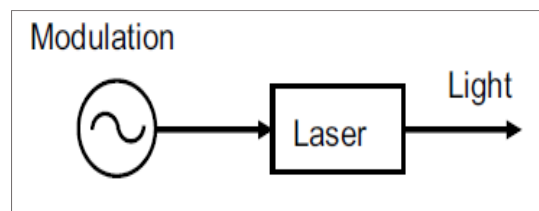

Figure 1. Chaos generation by external modulation technique.

For applications involving millimeter wave systems; *Radhakrishnan Nagarajan et. al.* experimented a Fabry-Perot laser type and demonstrated a system implementation with external cavity laser capable of transmitting and receiving narrow-band digital data modulated on a millimeter wave subcarrier at 35 GHz. That system, adapts sharpening pulses, i.e. in the absence of chaotic broad bands. This author also experimented a DFB Laser, the same as what we used, with FBG instead of external mirror and he indicated increasing noise, which is agree with what we achieved after the coherence collapse reached [2].

2. Semiconductor Laser with Optical Feedback

OFB, alternative name to it is self-mixing interference, means change in both laser intensity and polarization states with a small fraction of the output laser re-injected the laser cavity. Inserting anisotropy to this part, as a feedback, by components such as, polarizer, liquid crystals or wave plates, when they are placed into the feedback cavity bath, it is found that the laser become self-mixing interference. This is under modulation for that parameter in laser beam outside its cavity [3]. SL with OFB display large chaotic dynamic behavior, which are mapped as periodic oscillations, period doubling, quasi-period, and routes to chaos (coherence collapse). Phase variation, polarization, time delay for re-injected field back to laser cavity all associated with previous effects. For strong OFB, the induced oscillations frequency may be corresponding to laser external cavity resonance frequency.

Ref. [5] suggested a model employing uses lateral OFB of slow light to enhance the modulation bandwidth of a SL of type 'vertical cavity surface emitting laser (VCSELs)' with increasing modulation bandwidth up to 40 GHz. It is still not complete understood how fast we can directly modulate SL radio over fiber applications [4]. Transmitting coherent light wave with high bit rate into mono-mode optical communication systems needs more stable lasers with narrower linewidths. EC SLs is a one more effective practical technique for meeting this goal [5].

From the other hand, VCSLS SL with optical injection can also give another interesting chaotic dynamic, one of them is the so called optical rogue (RW) waves. Recently experimentally satisfied by ref. [6]. It was found that optical RW associated with optical injection appeared as a result of collision in chaotic pulses that developed due to the electrical pump injection [6].

Dynamics mentioned above, is governed by nonlinear light-matter interaction treatment in the active medium of the laser, quantum noise due to spontaneous emission and time-delayed feedback are both included. The ROF are capable to increase with the laser pump current. Due to the characteristic life time of both carriers and photons (10^{-9} s and 10^{-12} s, respectively) these ROF can take order of a few GHz.

Key effect for meeting OFB is the laser threshold, named threshold reduction, TR or ($\eta_{red.}$) which is calculated according to the following equation $\eta_{red.} = \frac{I_S - I_{OF}}{I_S} \times 100$ where I_S is the solitary laser threshold, I_{OF} is the laser threshold with optical feedback [7]. TR is the first considered and most important indication to approve the light-active medium interaction [8]. It was achieved that TR value depends on the technique at which the reflected light follows. These values of TR were ranged from 4.2% to 19.77%. Additional parameters also affected that parameter such as; external cavity length *i.e.* time delay for one round trip, type of that external cavity (stable or unstable cavity), back reflected beam ratio, laser type and its beam divergence, finally alignment at which all beams set, all these of course with a constant operating temperature [9]. Larger value OFB TR means that a strong feedback is reached, this can dramatically reduce the phase noises (frequency chirp) [5].

For each TR value there exists associated nonlinearities appears within laser emission at that value of feedback. Thus, for each pump current one can find different emission characteristics, when beam parameter changed as well, the dynamics become more complicated. Beam polarization, power attenuation, nonlinearity inserted externally into the delayed beam, amplification all can be changed to enrich these dynamics [10] and even inserting acoust-optic modulators to achieve frequency-shifted OFB measurements using a solid-state microchip laser (for sensing applications) [11]. The delay time can be measured by the equation: $\tau = 2n_{ex}L_{ex}/c$, where L_{ex} and n_{ex} is the external cavity length and refractive index. The model of external cavity is shown in figure 2, where r_2 is the internal cavity back mirror reflectivity, r_{eff} is the internal cavity front mirror reflectivity, and r_3 external cavity mirror reflectivity [12].

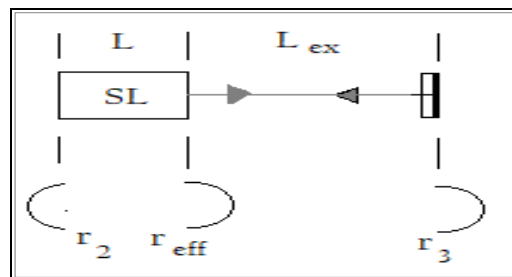

Figure 2. Depicts schematically a SL with external OFBB [12]

Due to the ROFs of the SL, the laser EC can be classified as a short external cavity, if the light delay time is of the order (or smaller than) the relaxation time (OFB takes order of hundreds of picoseconds); and long external cavity, if the light delay time is much longer than that time. Coherence Collapse (CC) effect refers to a large increase in the laser pulse linewidth of the laser mode (from hundreds of MHz to tens of GHz). This regime reached with moderate to high feedback strengths, and pump currents far above the solitary laser threshold [13].

3. Rate Equations with Modulation:

When specific parameters of the laser external cavity are modified, its output steady-state system became unstable to small fluctuations, current modulation intensity. This is due to either polarization or pump power that leads to the development of a periodic frequency modulation. Modulation intensity can be either spontaneous or stimulated. The pump power for such effect to occur is only slightly above the solitary laser threshold. This continuous wave (CW) emission was found to be more unstable, where its emission can undergo from spontaneous temporal modulation into a periodic pulse train. This translation from periodic modulation dynamics are typically described in the spatiotemporal domain [6].

Since the pioneer study carried out by *R. Lang et al.*, many studies dealt with SL under OFB. R. Lang suggested theoretical model and approved it experimentally for the laser stability with weak optical feedback which is based on traditional analysis. The model is hybrid (mixed) cross between two models; i.e both node and traveling wave approach. They have been experimentally approved that a laser with external OFB can be multi-stable and show hysteresis-like phenomena, identical to those of nonlinear Fabry-Perot resonator. It has also been indicated that the dynamic properties of these lasers are strongly affected by laser external cavity feedback, this is depending on interference conditions between reflected light and the field constructed inside the laser diode internal resonator. An external feedback term is added under the steady-state conditions, in to a solitary SL equation in complex form, thus the field equation for a complex cavity laser setup is such that [7];

$$\frac{d}{dt}E(t)e^{i\Omega t} = \left\{ iw_N(n) + \frac{1}{2}(G(n) - \Gamma_0) \right\} E(t)e^{i\Omega t} + \kappa E(t - \tau)e^{i\Omega(t-\tau)}$$

where; $w_N(n)$ is the resonant frequency for diode cavity longitudinal mode, it is defined with an integer N as $w_N(n) = N\pi c/\eta l_D$, Γ_0 is the cavity loss of the diode, and c is the light velocity in vacuum, last term on the right-hand side represents the external feedback, κ is a coefficient related with cavity parameters, and it is given as; $\kappa = ca/2\eta l_D$, external cavity mirrors reflectivities are r_1 and r_3 ; $a = (1 - r_2)(r_3/r_2)^{1/2}$ is a coupling strength measure between the two cavities. For above expression that associated with external feedback, multiple reflections in laser external cavity have been neglected [7].

This classical approach meets acceptance with only weak feedback from a single mirror, and has been shown to be a limit of more accurate models.

For the problem of emission with strong OFB, dynamics of SL under IM and OFB are described by time-delay rate equations of the carrier number, photon number and optical phase. According to this model given by ref. [14], gain of threshold is determined by lifetime of photon inside internal laser cavity of length L_D , and refractive index n_D , and OFB function that describing the time delay of laser light doing the round trips (i.e., multiple reflections) within the external cavity (of length L_{ex} and refractive index n_{ex}). This cavity formed from distance between laser facet (of reflectivity R_{eff} and EC mirror R_3) figure 2. Coupling coefficient K_{ex} defines the strength of OFB which is determined by the ratio between R_{eff} and R_3 . Under single type modulation, the injection current $I(t)$ is constructed from a bias component I_b , and a sinusoidal component of wave amplitude I_m and modulation frequency ν_m [14][15];

$$I(t) = I_b + I_m \sin(2\pi\nu_m t)$$

Proper analysis includes the coupling of laser diode to an external optical system, must treat open cavities type, i.e. cavities that has low quality factor. Even for a single laser diode cavity, the

primary approach of defining basic modes with equivalent mirror losses uniformly distributed along the cavity, underestimates the coupling between spontaneous-emission noise inside the laser mode [16].

Thus, complete picture for modeling laser dynamics under OFB must including an operator that completely describes feedback effects, then applied this technique to various suggested feedback geometries [12], variation in the diode internal cavity optical path length L_D , which is caused by active medium crystal refractive index variation due to the active region instantaneous temperature change with current variation [7].

Hjleme in his series researches, presented a theoretical model extended the analysis to include all ROs, and frequency and intensity noise spectra with developing it in term of convenient operators that easily transform in the linearized noise spectra. The theory is valid for arbitrary (dynamical) strong feedback [15].

4. Experimental Set up:

Throughout this study, air as a linear medium ($n \approx 1$), is referred to as a free space. Chaos generation via self OFBB is divided into two types: fiber loop-mirror delayed OFBB and air EC delayed feedback. According to latter technique different geometrical configurations are available. The selection was located in to the one that given in figure 3.

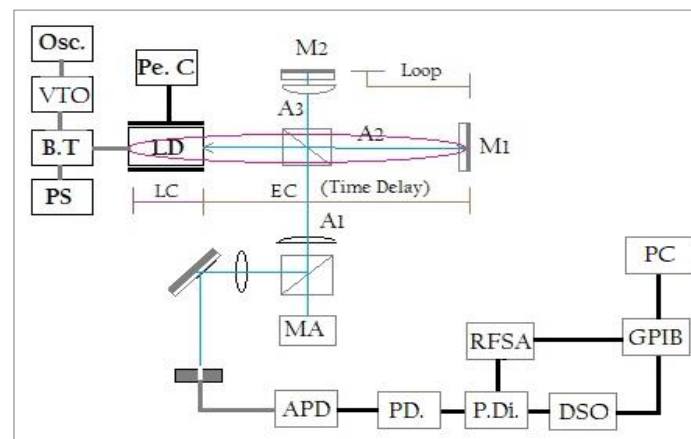

Figure 3. Experimental set up configuration for modulation in to chaos. Abbreviations are as mentioned in text.

As shown in figure 3; LD: is *ML725B11F* ThorLabs co. laser source, Pe. C.; is Peltier cell/temperature stabilized - better than 0.02°C , DSO: is *TDS6124C* Tektronix co., digital storage oscilloscope, 12 GHz bandwidth, RFSA; is *MS2665C* Anritsu co., 21.2GHz, RF spectrum analyser, B.T.; is *ZFBT-6GW+*, Minicircuits co bias-tee to mixing pump current and frequency, P.Di.; is (6 dB) *Picoseconds* Pulse lab. Co. power divider, modulators, which are: *2019A* Marconi, 1.024GHz SG, X2 FK-3000+, *frequency multiplier*, VTO: 8000 HP Varactor-Tuned Oscillators, "600 MHz to 10.5 GHz" and PC is the lab. computer for deriving *Labview* program. Light submitted by LD pass through 50:50 non-polarized beam splitter, NPBS, one part, A_1 , from this light reflected toward the output direction, while the transmitted part, A_2 is going to hit a high reflectivity (99.5%) dielectric external mirror M_1 . The later part back reflected from the right side OFB NPBS itself.

Again, part OFB it will transmit directly to inside the LD and the reflected part, A_3 , will go to a second (perpendicular to M_1) dielectric mirror M_2 (with reflectivity OFB 99.5%), then back to the same NPBS. Part from it will transmit (interfering with A_1) to the output direction and the reflected part will also enter the LD. Accordingly, the EC length will be summation of 85cm plus 20cm, i.e. double EC geometry is constructed. Overlap will give a various types of modes to inside the laser internal cavity. This will disturb solitary lasing RO modes modifying the overall output via the coherence collapse under the effect of strong feedback. The back reflected power is controlled by a variable filter, and the matching between the forward and backward beams is monitored by a D.C. monitoring for the laser signal and with controlled beams by the 3-D mirror mounting.

External time delay for part of back reflected beam is 5nS (single long path), and another part delay will be 1nS (single short path), and a third part will be a summation for both of these two delays, 6nS. As a result, under the strong feedback perturbation, the laser will run with very broad band chaotic carrier. Selection for this geometry will make the signal more complicated and be more stable and gives rise to security degree. TR ratio for this experiment was 10.85% at constant operating temperature 14.8 ± 0.02 °C. Temperature for heat-sink is applied and controlled more precisely to avoid both drift and longitudinal mode jumping. Noting that MA in output arm of figure 3 is refer to our more analysis direction not included in this article.

Light is passing through the NPBS two times, i.e. beam is suffered from attenuation two times, in addition to the remaining loss from mirrors with reflectivity of $> 99.5\%$. A NPBS was inserted between the laser focusing lens and the EC mirror M_1 , as shown in figure 3, and the largest power of the beam after passing the NPBS is the A_2 , in order to increase the feedback strength. Attenuation plate (with different values) are placed between the feedback mirror and the beam splitter while the other option was to decrease or increase feedback strength by EC mirror micro tuning in x or y direction, which was not preferred.

Main feature of the large cavity regimes is that laser dynamics are not sensitive against variations of the phase with which reflected light re-enters inside the laser cavity. Noting that, even though it appears that the frequency stability is better for longer distance cavities, the number of possible cavity modes also increase, making the laser subject to mode jump. The sensitivity of the operating frequency to external cavity resonance variations or equivalently variations of cavity is given by [1];

$$\frac{\partial \omega_0}{\partial L} \cong \frac{-2}{\lambda} \Delta \omega_{ex}$$

where $\Delta \omega_{ex} = 2\pi/\tau_L$ is the free spectral rang for cavity. In other words, a change of length of $\lambda/2$ will tune the laser emission frequency an amount equal to the free spectral range. Cavity length perturbations could easily be due to air temperature, pressure variations that could set the limit on the stability of a real system [12]. While a mode hopping between external cavity modes in analogy with noise driven transitions of a potential between potential valleys.

The aim of present work is to achieve maximum broadening chaos signal in order to modulating it with highest FM message. This goal was achieved in practice with an 85cm length, according to our configuration set up.

The laser with a relatively short EC and weak feedback strength works in a stationary regime independent on how much is the pumping. However, for a longer EC the laser dynamics is very rich. Thus, in order to generate the chaos, as a carrier signal, in which effect, CC should be achieved; the latter is not possible for short length cavities. The region of which is continuous unstable, and independent of phase, which requires larger lengths ECs [16]. Thus laser should be running with high instabilities dynamics and out of his steady CW state.

From view point of interference theory, as mentioned above, laser light inside cavity is a standing wave between two cavity mirrors. This standing wave consists of two light waves with equal amplitudes and frequencies but with opposite propagation directions, this theory is true for both internal and also external laser cavities. Non-linear interaction between the EC modes (separated by a frequency $f_{ext} = 1/\tau$) and the RO frequency, f_R of the solitary free running laser are dominant in systems that subjects to OFB [17, 18].

EC generates series resonant frequencies to the laser emitted spectrum. Competition and interplay between them and internal laser cavity frequencies becomes a function to the feedback level. Increasing this parameter causes successive new instabilities which give rise to chaotic behavior, especially in case of running the laser far away from its free running threshold. Several different chaotic transitions might be occurring, but, the *quasi-periodic-route* is the most common one.

By changing the strength of feedback or its delay time, laser can be operated in a chaotic pulsing state. However, the rate of laser pulsation is limited by its RO frequencies, which cannot be increased by adjusting the feedback parameters, while, this is possible in OFB regime [19].

According to that, RO and the EC frequencies appears sequentially and are incommensurate. Generally, in time delayed systems, for small delay, low dimensional attractors arise, and on the opposite, in the *long delay* limit, more complex high dimensional dynamics appears. Since time delayed dynamical systems appear in many physical configurations, a lot of potential has been done to understand how the dynamics and the complexity OFB the attractors vary with the delay time τ [8]

In general, dynamics of laser output originate from destabilized laser that has RO of the solitary SL and the interaction of the system modes with the laser external cavity modes ($f_{EC}=1/\tau$) for different feedback parameters. RO is given by;

$$f_{RO} = \frac{1}{2\pi} \left(\frac{G_N E_s^2}{\tau_p} \right)^{1/2}$$

Where E_s is the free running electric field amplitude and is given by; $E_s = ((J - N_{th}/\tau_s)\tau_p)^{1/2}$ where N_{th} is the threshold carrier density.

For the laser system subjecting to OFB, period doubling rout occurs when the RO and the EC modes or their harmonics are locked with each other's. As the feedback strength is increased, the new created frequencies follow this sequence; $f_1, f_1/2, f_1/4, f_1/8 \dots$ till getting chaos. Route in principle occurs when delay ratio, f_{RO}/f_{EC} (or τf_{RO}), is small. While quasi periodic route of ten occurs for high delay portion, starting to bifurcate in phase space from stationary solution to stable limit cycle followed by torus as the feedback increases. The first start frequency f_1 is very close to f_{RO} , while the second oscillation frequency f_2 originates from the fundamental EC frequency f_{EC} . The next two frequencies f_1 and f_2 will aligned in order to lock at ratio of $f_1/f_2 = 4/3$ due to the nonlinear coupling.

As the feedback ratio increases, a third oscillation frequency is arising, which is important for chaos, it construct from the second cavity mode. Chaos occurs most frequently via quasi-periodic route, as the frequency locking condition is not usually satisfied. Even when satisfied, a small change in either laser external cavity length ($\sim \lambda/4$) or the injection current ($\sim 0.1\%$) can break down the locking and different route produced [20].

5. Results and discussion:

5.1. Free Running Laser:

Continuing to our experiments for laser operation with OFB, results with 20cm EC (via linear air) which is given in Ref. [10] and that via optical fiber Ref. [21]. Practical laser operation characteristics in free running case is examined at first to ensure its real operation without OFB. For this measurements, A_2 & A_3 beam directions to exclude from any feedback by blocking them. The first NPBS is located at 5.7cm in front of the laser output. The measured splitting ratio in practice for the real laser wavelength was: 50.50%: 43.84% for I_1 : I_2 , respectively. That's means a 9.4% portion is considered as a loss.

Temperature was chosen to be: 14.8 °C, in order to avoid any water drops which probably condensed on laser body due to temperature difference inside the laboratory. The measured FR laser threshold current was 4.03mA, figure (4) and its maximum FR output measured optical power is 6.73mW at 30mA. This is after including the reduction of power due to both NPBS and absorption scattering due to dust losses. In case of FB, the measured TR ratio is 10.58% with maximum optical power increase ratio 0.153%.

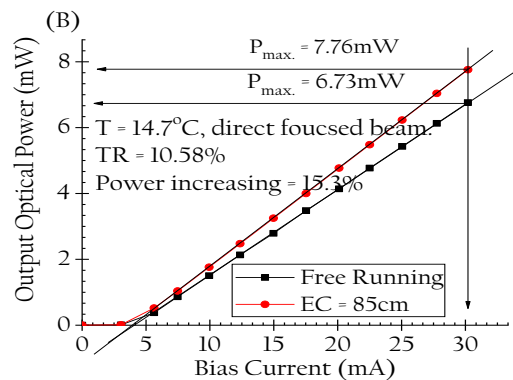

Figure 4. Experimental measurements for light – current two curves with and without and OFB

Observation with free running laser in majority pump current levels shows that LD spectrum has an emission spectrum contains more than single longitudinal mode with low mode suppression ratio, and wide line shape. As a result, the single lasing mode was found dominant in two bias current levels, near FR threshold and far away from it. In intermediate, the laser makes interplay between the two dominant neighbour frequencies.

5.2. Laser with optical feedback:

Running the laser under OFB, in 85cm doubly EC, stimulating laser response extraordinarily. It is easy to notice a wide broadening in its pulse line shape function, fig. (5), Linear fitting relation resulted between pump current and that function. where the laser with OFB by defaults translated from CW into pulsation mode. Laser was operated at multiple longitudinal lasing modes in majority of its injection current levels, with a large reduction (78%) in its optical signal amplitude in case of OFB than that in FR case.

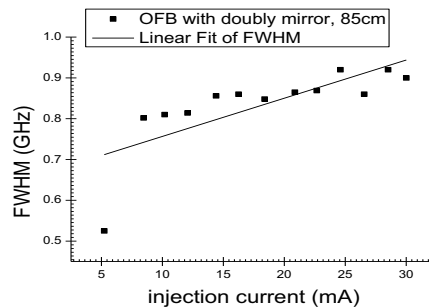

Figure 5. Experimental results between laser pump current and FWHM.

For the selected pump current level, in which purely single mode lasing laser operation in a free running, we select this level to exam the spectrum under optical feedback. Results given in figure 6, shows that the spectrum be boarder and multi spikes growth under the influence of strong feedback. Spectrum occupy a twelve GHz in wide, and follow a Gaussian fitting. Measurement is done with RF spectrum analyser furthermore the DSO and both spectra are identical. Those frequencies gave the picture of interfering between solitary laser frequency with EC frequency which was very sensitive to the laser pump level.

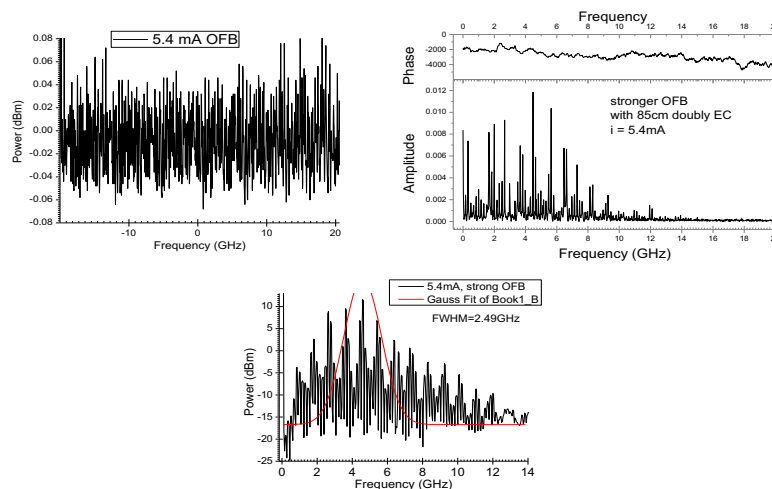

Figure 6. Dynamics associated with stronger OFB in 85cm doubly EC without modulation.

5.3. Masked Modulation:

High-frequency modulation of laser beams is important requirement for various fields including atomic physics, metrology, and optical communications [16][22]. The high-frequency modulation of LDs has been a subject of active research for signal transmission in digital and analogue fiber-optic communications, fiber-optic links, delay lines, and phased array beam steering. High-frequency modulation of InGaAsP has achieved bandwidths of 23 GHz in periodic laser emission [23]. Thus, it was interesting for our study to increase modulation bandwidth in chaotic laser emission instead.

Modulation in present set up, given in figure 3, was made by modulation into the DC current injected into the LD, i.e. as an AC signal. According to measured RF spectra, observations indicated

in the last section. The obtained chaos signals were wideband. It was even in low laser deriving currents, at least 8 GHz OFB bandwidth; otherwise, it reaches (12+) GHz in high value deriving currents. This is roughly the same observation for TR = 4.9% and 10.58%.

Experiments in modulation started by using the signal generator alone i.e. $\nu_m = 1.040\text{GHz}$, then a wide band (140 to 3000 MHz) frequency multiplier (FK-3000, constant output, doubler harmonic conversation) is inserted between signal generator and bias-tee for doubling the frequency value before modulating it. Maximum modulation, in this stage, was up to 2.08GHz. In order to increase modulation limit, an oscillator (VTO-8240, 2400–3700MHz then, VTO-8650, 6500-8600 MHz, were used. Both were Varactor-Tuned Oscillator frequency multiplier. As it is shown in figure 7, the FM message was implemented completely within the chaos carrier signal. This was available for four different laser input current levels.

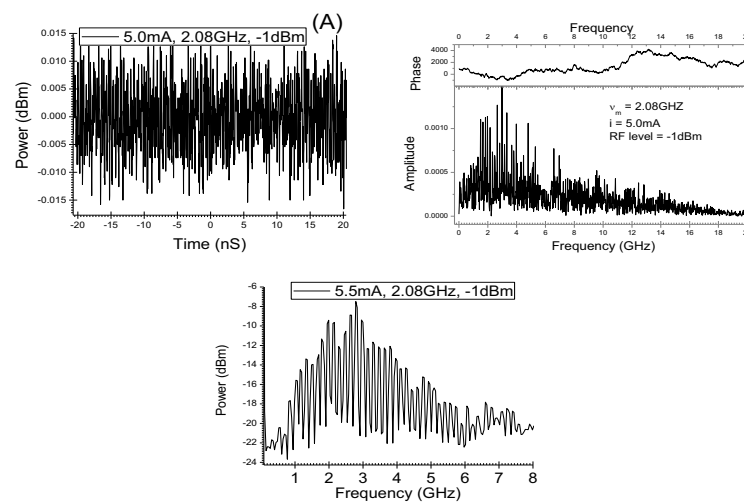

Figure 7. Laser spectra with $\nu_m = 2.08\text{GHz}$ within chaos signal generated by doubly EC, 85cm in length.

As shown in figure 8, there were three spectra for higher RF levels ($\nu_m = 3.76\text{GHz}$) harmonics are easy to distinguish in periodic laser oscillation when modulating a solitary laser experimentally.

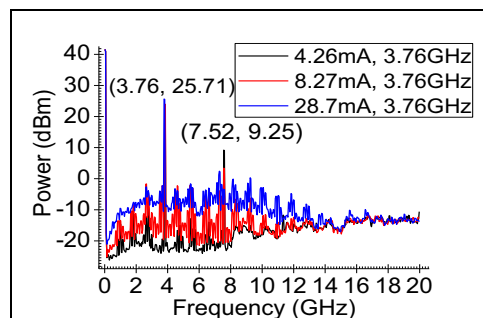
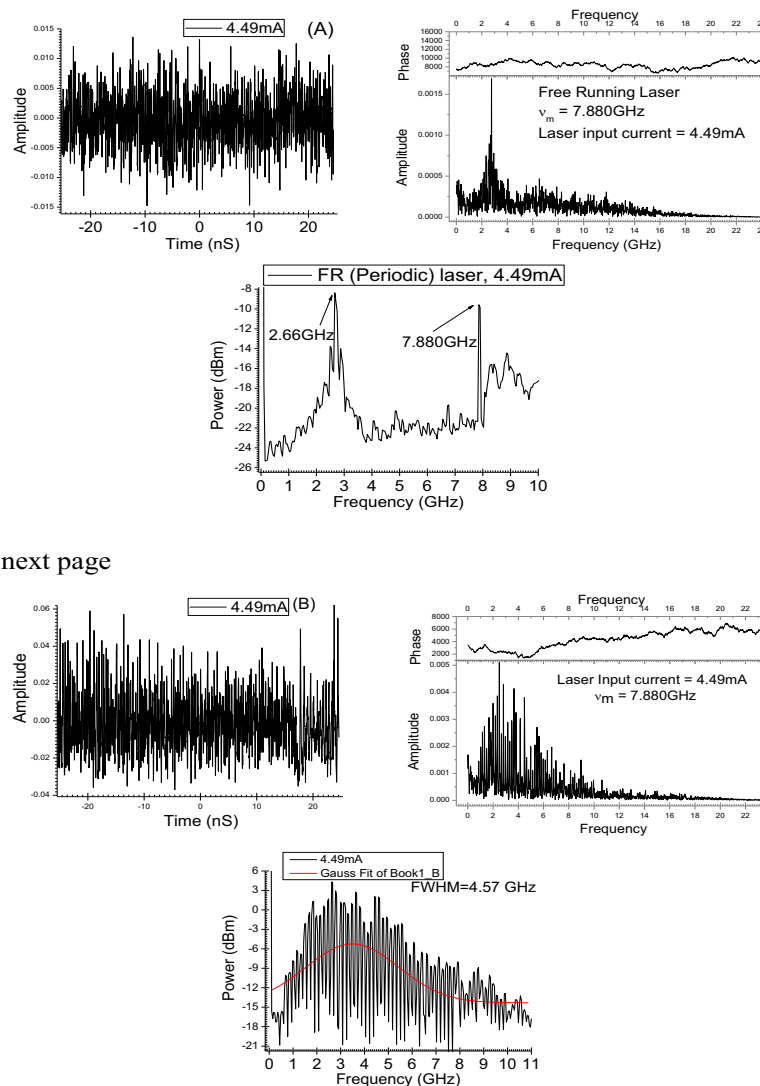

Figure 8. Laser periodic RF spectra with $\nu_m = 3.76\text{GHz}$ for three modulation Rf levels.

In figure 9 row-A, FR laser emission has a sharp optical spectrum; with a characteristic peak at 7.880GHz, which is exactly the modulated signal. Modulation with the same value but laser

is under the effect of OFBB is given in the same figure 10 row –B. Laser input currents, was near FR threshold, in which, the message was successfully fully hidden within chaotic carriers that has an extended to more than 10GHz signal.



Follows in the next page

Figure 9. Laser spectra associated with modulation value $v_m = 7.880\text{GHz}$ and RF level (+9dBm). (A) Modulation with a FR laser, and (B) Modulation with a chaotic oscillation.

This result disagreed with what indicated by Rongqing Hui [5]. He mentioned that long EC with OFB is preferred in the strong-feedback regime, in which laser operates stably with ‘narrower’ linewidths for all phases of the feedback. While, *L. Hollberg et.al* [24] showed that the maximum available v_m for SL by direct current modulation is: 3GHz/mA, but with free running. Worth to mention is that laser ability for direct bias current modulation can be calculated by the so called, FM index, ($\beta = \frac{I_{rf}}{I_{dc}}$) which means decrease of β with increasing laser operation bias current.

Enhancement of DFB SL available by the technique of EC. In such a technique, internal laser cavity eliminated and v_m is matched to the free spectral range of OFB in the EC.

6. Conclusions:

The direct modulation of SLs can be enhanced as well as employed for hiding a transmitted message. This is inside the resonant frequencies that generated intentionally by a long EC. Complexity for this cavity geometry could generate increased complicate spectrum for the transmitter. This spectrum can also be broader by doing external modulation to the external part of that laser cavity, by change any part of its beam parameters.

7. References

- [1] Uchida Atsushi 2012 Optical communication with chaotic lasers: applications of nonlinear dynamics and synchronization (Wiley-VCH Verlag & Co. KGaA, Boschstr. 12, 69469 Weinheim, Germany, Printed in Singapore) chapter 2 pp 44.
- [2] Nagarajan Radhakrishnan, Levy Shmuel and Bowers John E 1994 Millimeter wave narrow band optical fiber links using external cavity semiconductor lasers J. Lig. Wave Tech. **12**, no. 1 pp 127-137.
- [3] Chen Wenxue and Hu Xinhan 2016 Intensity modulation in laser with asymmetric optical feedback Elsevier GmbH J. of Optik **127**, Issue 4, , pp 2083-2085.
- [4] Ahmed Moustafa, Bakry Ahmed, Altuwirqi Reem, Alghamdi Mohamed S and Koyama Fumio 2013 Enhancing modulation bandwidth of semiconductor lasers beyond 50 GHz by strong optical for use in millimeter-wave radio over fiber links Japanese J. Applied Physics, **52** No. 12R 124103 pp 1-5.
- [5] Hui Rongqing and Wu Yizun 1989 Noise and frequency chirping in external-cavity semiconductor lasers J. Optics Letters, **14**, No. 13, pp 668-670.
- [6] Khashi Hani Jassim 2018 Vector optical rogue waves in mode-locked fibre lasers A Ph.D. dissertation, Engineering and Applied Science, Aston Institute of Photonics Technology, Aston University.
- [7] Lang Roy and Kohroh Kobayash 1980 External optical feedback effects on semiconductor injection laser properties IEEE J. Quant. Electr., **QE-16**, no. 3, pp 347-355.
- [8] Hemed Ayser A 2011 Chaos generation methods in optical communication systems A Ph.D. dissertation department of Physics college of Science, University of Baghdad, Iraq.
- [9] Hemed Ayser A, Chead Baha T, Khashi Hani J 2015 Threshold reduction for a diode laser by using the technique of optical feedback J. college of education, Mustansiriyah University, Iraq, **16** No.1, pp 35-52.
- [10] Hemed Ayser A, Mohammad Adnan H 2016 Studying laser diode dynamics with optical feedback from 20cm free space external resonator, Ibn Al-Haitham J. Pure and Applied Science, University of Baghdad, Iraq, **29**, issue 2.
- [11] Zhu Kaiyi, Chen Hongfang, Zhang Shulian, Shi Zhaoyao, Wang Yun and Tan Yidong 2019 Review frequency-shifted optical feedback measurement technologies using a solid-state microchip laser, J. Appl. Sci., **9**, 109 pp 1-27.
- [12] Hjelme Dag Roar, Mickelson Alan Rolf and Beausoleil Raymond G 1991 Semiconductor laser stabilization by external optical feedback IEEE J. of Q. Electronics, **27**, No. 3 pp 352-372.
- [13] Aguado Andres Aragonese 2014 Experimental study of feedback-induced dynamics in semiconductor lasers: from symbolic analysis to subwavelength position sensing, A Ph.D. dissertation department of Physics and nuclear, University of Catalonia.
- [14] Ahmed Moustafa Farghal, Bakry Ahmed, Koyama Fumio 2015 Application of strong optical feedback to enhance the modulation bandwidth of semiconductor lasers to the millimetre-Wave Band, World Academy of Science, Engineering and Technology, International J. Physical and Mathematical Science **9**, No:1 pp 17-22.

- [15] Hjelme Dag Roar and Mickelson A R 1987 On the theory of external cavity operated single-mode semiconductor laser, IEEE J. Quantum Electronics. **QE-23**, pp 1000-1004.
- [16] Jones R J, Spencer P S, Lawrance J and Kane D M 2001 Influence of external cavity regime in laser diodes subject to optical feedback, IEEE proc. Optoelectron., **148**, no.1 pp 352-372.
- [17] Lv Liang, Gui Huaqiao, Xie Jianping, Zhao Tianpeng, Chen Xiyao, Wang Anting, Li Feng, He DeYong, Xu Jun, and Ming Hai 2005 Effect of external cavity length on self-mixing signals in a multilongitudinal-mode Fabry–Perot laser diode, J. Applied Optics, **44**, no. 4.
- [18] Masoller Cristina 2001 Anticipation in the synchronization of chaotic semiconductor lasers with Optical feedback, J. Physical Review Letters, **86**, no. 13, pp 2782-85.
- [19] Lee Min Won, Larger L and Goedgebuer J P 2003 Transmission system using chaotic delays between light waves, IEEE J. Quantum Electronics, **39**, issue 7.
- [20] El-Azab Jala M and El-Nadi Adel 2007 A global study of the Influence of optical feedback on a semiconductor laser diode, EUROCON IEEE international Conference on “Computer as a Tool”, Warsaw, pp 1208-13.
- [21] Hemed Ayser A and Salah Rasha 2020 Enhanced emission perturbations associated with mixed optical injection in laser diode The 8th International Conference on Applied Science and Technology (ICAST 2020) AIP Conf. Proc. 2290, 050021 pp1–11.
- [22] Pisarchik A N and Ruiz-Oliveras F R 2007 Dynamics of a semiconductor laser with two external cavities. PIERS online, **3**, no. 4, pp 452-56.
- [23] Poulin M 2009 Compact narrow line width semiconductor laser module. Québec, Canada, G1P 4S8, Proc. of SPIE, **7325** 73250O pp 1-8.
- [24] Hollberg L and Ohtsu M 1988 Modulatable narrow-line width semiconductor lasers J. Appl. Phys.Lett. **53** issue 11.

Acknowledgments:

The authors would like to thank *Mustansiriyah University*, (www.uomustansiriyah.edu.iq) *Baghdad – Iraq* and *University of Strathclyde*, (www.strath.ac.uk) *Glasgow, UK*, for their support in the present work.