

Irene Moreno<sup>1, 2</sup>, David McKechnie<sup>1</sup>, Leo Lue<sup>1</sup> and Javier Cardona<sup>1, 2, 3</sup>

<sup>1</sup> Department of Chemical and Process Engineering, University of Strathclyde, Glasgow, UK.

<sup>2</sup> EPSRC Future Manufacturing Research Hub for Continuous Manufacturing and Advanced Crystallization (CMAC), Glasgow, UK.

<sup>3</sup> Department of Electronic and Electrical Engineering, University of Strathclyde, Glasgow, UK.



## Fick's law is not always appropriate to describe mixing in antisolvent crystallisation processes

### 1. Introduction

- **Mixing** greatly impacts the outcome of antisolvent crystallization processes, such as the CSD or the final crystal morphology [1].
- Poor understanding of this process leads to unwanted phenomena such as **oiling out** and **uphill diffusion** [2], as depicted in **Figure 1**.
- This project focuses on developing a **diffusion model** for the microscale, illustrated in **Figure 2**.

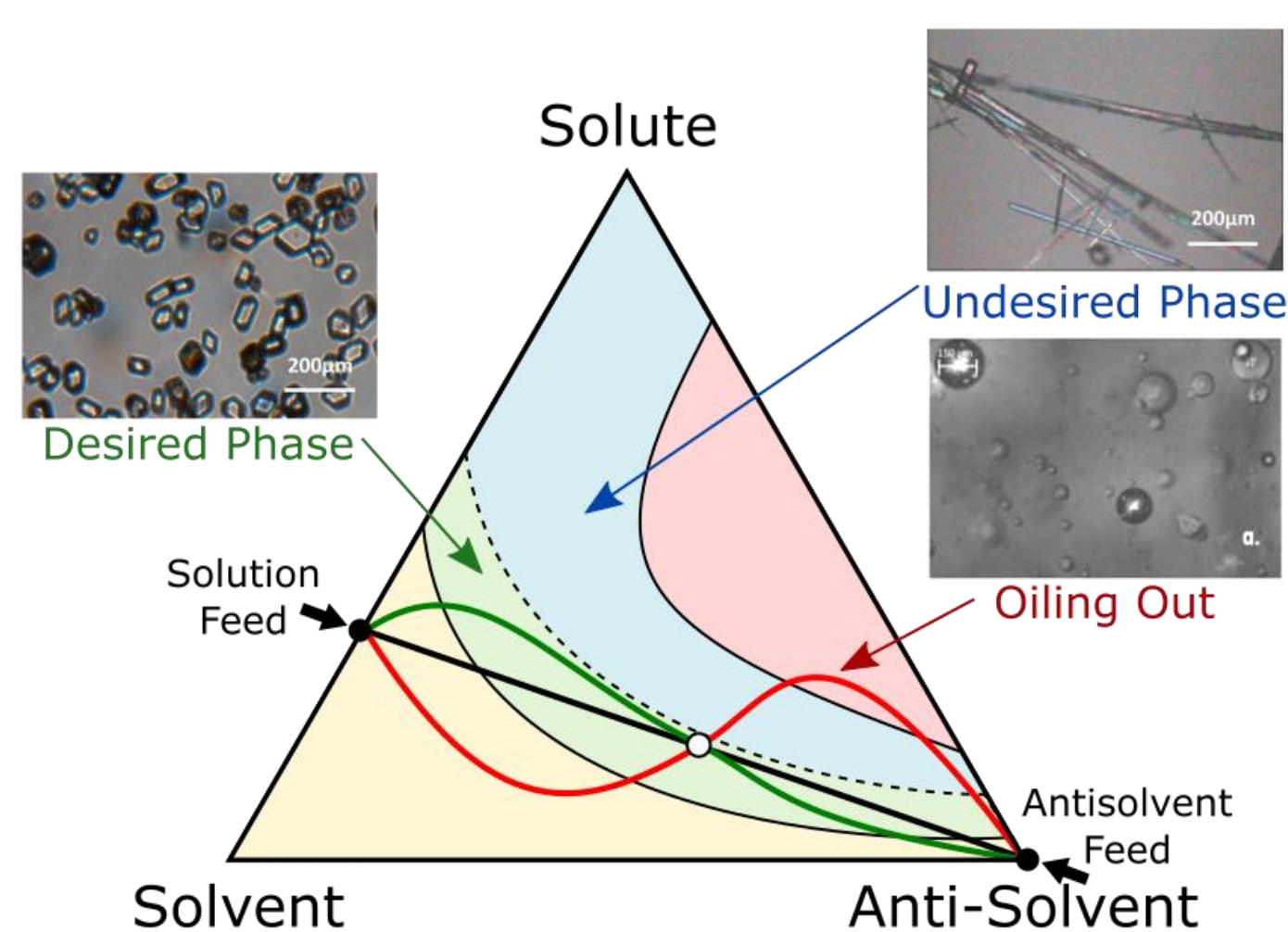

**Figure 1.** Ternary phase diagram illustrating that the crystallization path dictates which outputs are obtained.

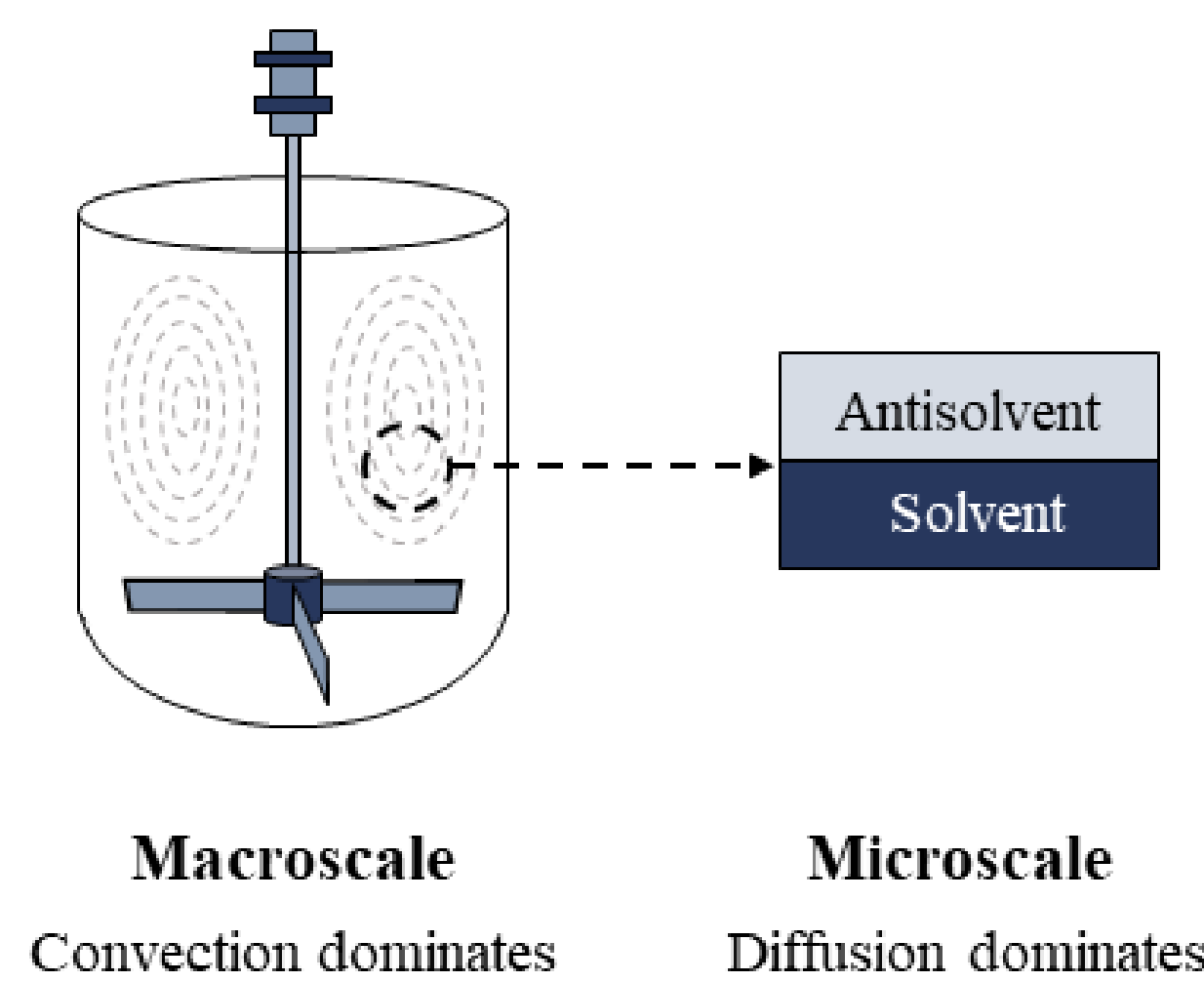

**Figure 2.** Diagram illustrating the different scales of mixing in a crystallizer, and their main transport mechanism.

- As an alternative, we propose a novel model based on the **Cahn-Hilliard**, **Maxwell-Stefan** and **Margules** equations.

#### Fick's diffusion law

$$J_A = -D_{AB} \cdot \nabla x_A$$

- **Concentration gradient** as the driving force
- Cannot be applied to phase-changing systems
- Assumes **ideal behavior**

#### Cahn-Hilliard-like phase-field model

$$\frac{\partial x_A}{\partial t} = \nabla [D_{AB} \cdot \nabla x_A] + \nabla [D_{AB} x_A \cdot \nabla [A(1 - x_A)^2 - \epsilon^2 \nabla^2 x_A]]$$

- **Chemical potential gradient** as the driving force (Maxwell-Stefan)
- Considers interphase minimization due to surface tension ( $\epsilon^2 \nabla^2 x_A$ )
- **Margules activity model**

### 2. Methodology

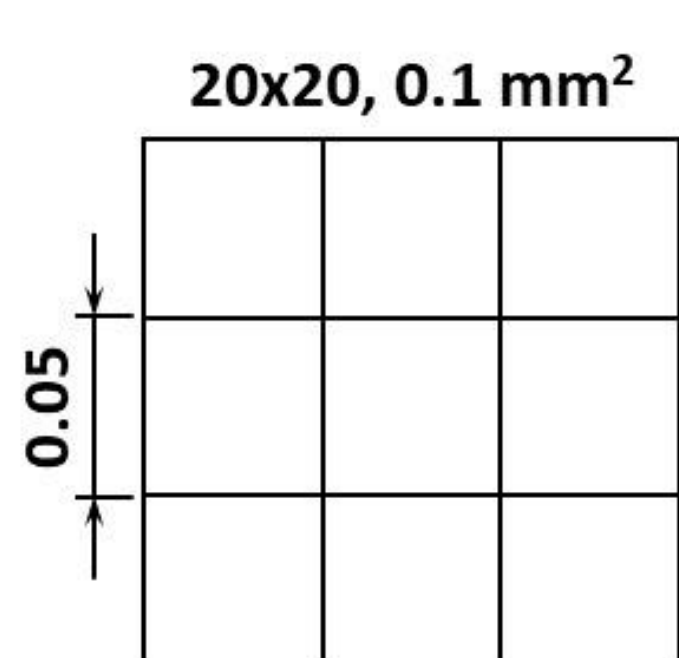

- **Equation discretisation:** finite volume method through FiPy library in Python
- **Boundary conditions:** zero gradient.
- **Initial conditions:** a layer of solvent over a layer of antisolvent, and a mixed phase.
- **System:** 2D, water and ethanol.

### 3. Preliminary results

#### System evolution: Fick's law

The model outcome is always a homogeneous system, regardless of what the components of that system are.

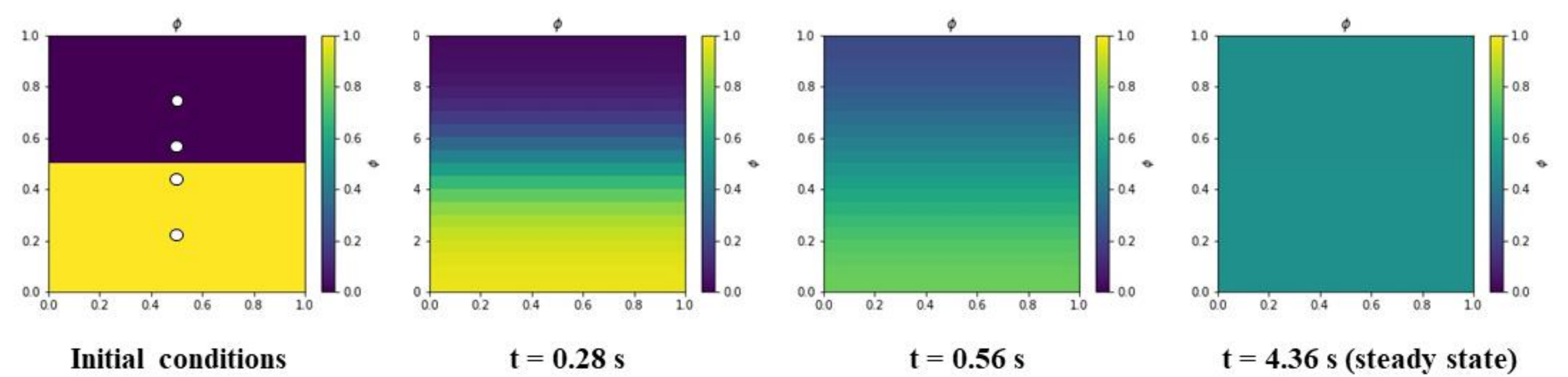

#### System evolution: Cahn-Hilliard-like phase-field model (A = 3)

The model accounts for the species forming the system through the value of A and yields a different outcome depending on that.

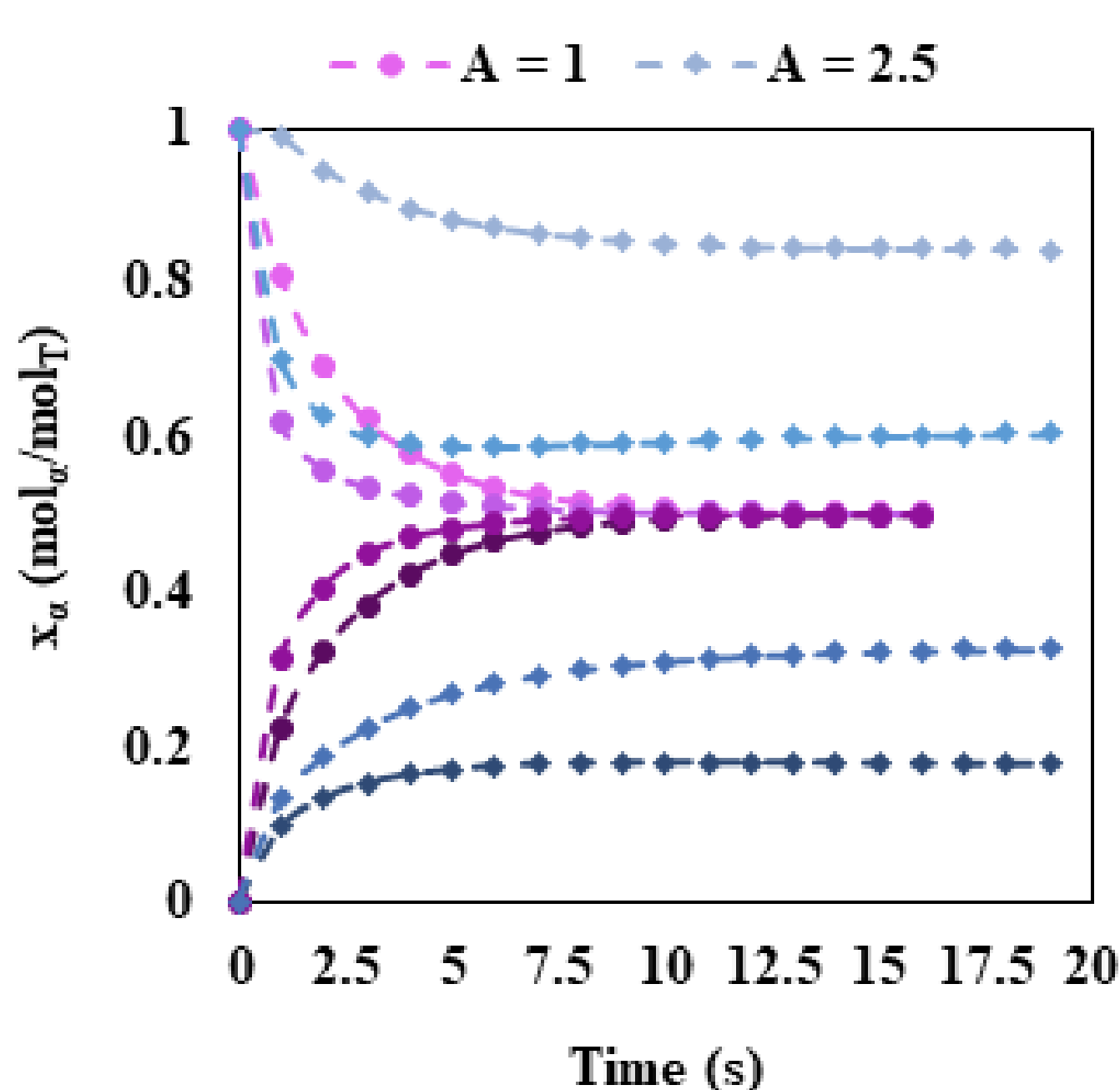
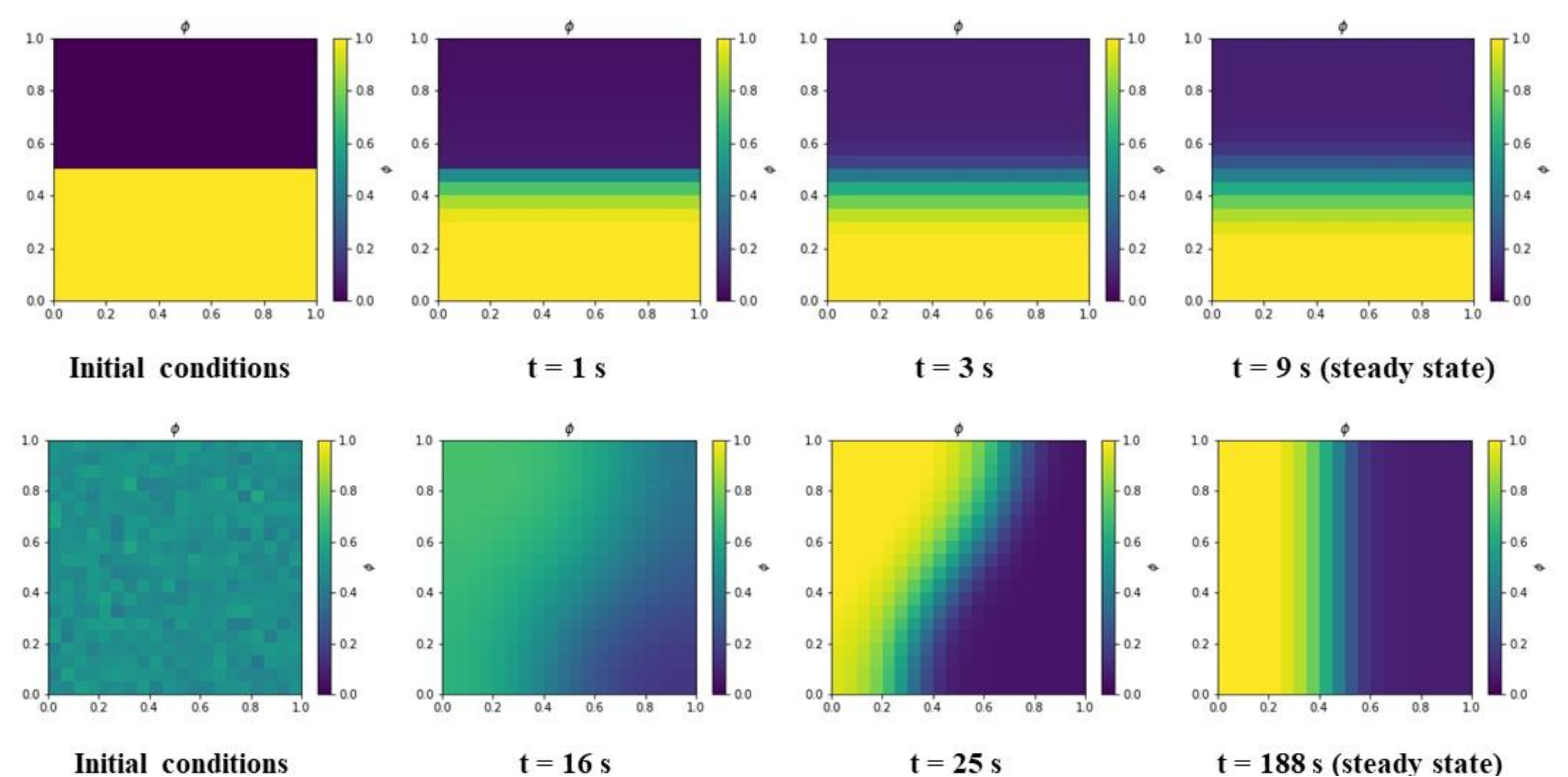

**Figure 3.** Time evolution of the white points shown above. Different values of A give a quicker/slower evolution towards a homogeneous/two-phase system.

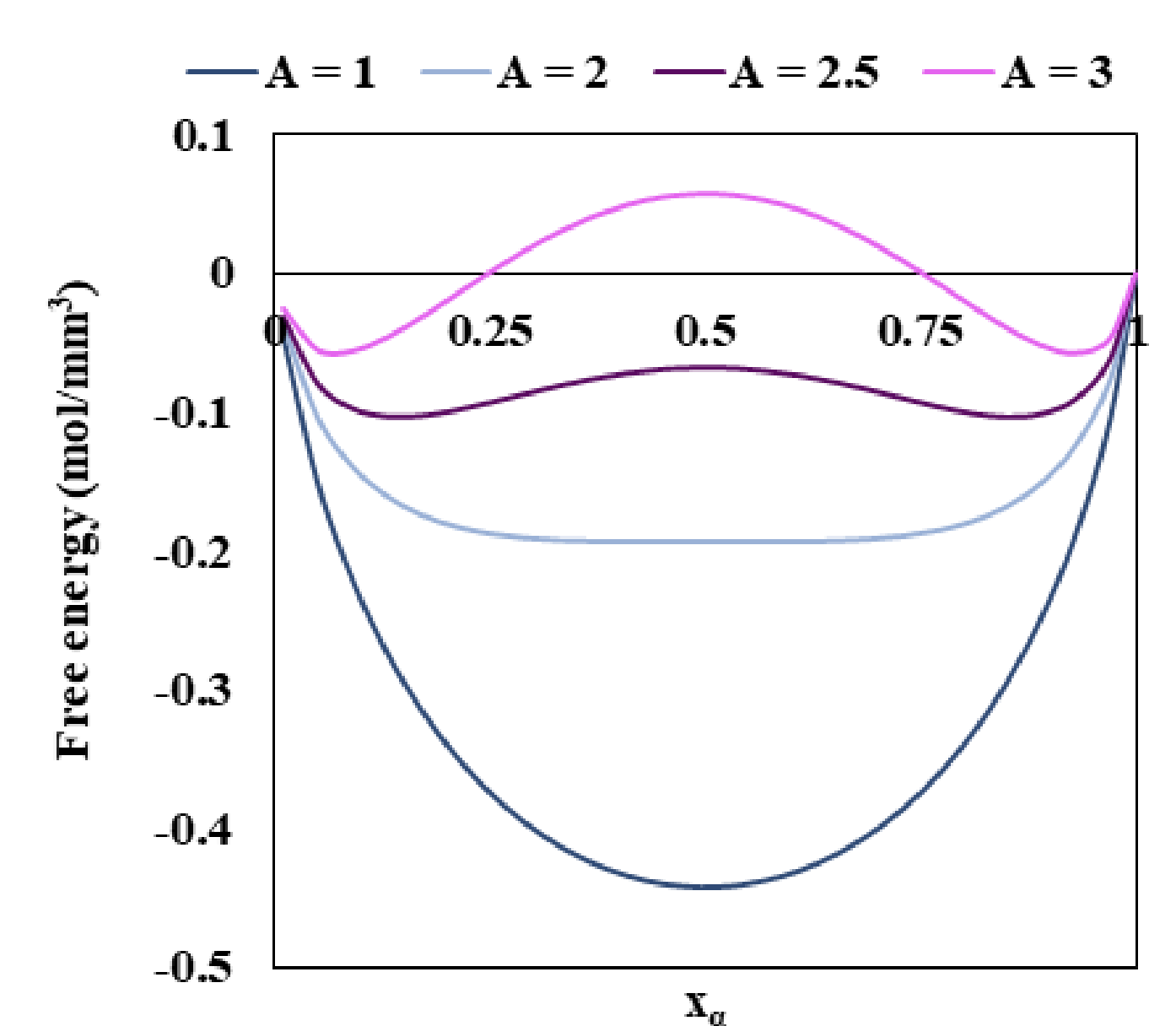

**Figure 4.** Margules free energy function for different A values. A > 2 yields a two-phase system, since the function has two minima instead of one.

### 4. Conclusions

- Fick's law is not an accurate representation of non-ideal systems.
- The model we have developed is promising for the simulation of these non-ideal systems.

**Acknowledgements:** EPSRC Future Continuous Manufacturing and Advanced Crystallisation Research Hub (EP/P006965/1) and the University of Strathclyde.

**References:** [1] A. Lewis, M. Seckler, H. Kramer, G. van Rosmalen, ISBN: 9781107052154. [2] R. Krishna, DOI: 10.1039/c4cs00440j