

Multi-criteria risk assessment approach for components risk ranking– The case study of an offshore Wave Energy Converter

Uzoma Okoro*, Athanasios Kolios^{1*}, Lin Cui[†]

*Centre for Offshore Renewable Energy Engineering, School of Energy, Environment and Agrifood, Cranfield University, Cranfield, MK43 0AL, UK

[†]National Ocean Technology Centre, Tianjin, China

Abstract

Experts' judgement is employed in offshore risk assessment because reliable failure data for quantitative risk analysis are scarce. The challenges with this practice lies with knowledge-based uncertainties which renders risk expression and estimation, hence components' risk-based prioritisation, subjective to the assessor – even for the same case study. In this paper, a new risk assessment framework is developed to improve the fidelity and consistency of prioritisation of components of complex offshore engineering systems based on expert judgement. Unlike other frameworks, such as the Failure Mode and Effect Criticality Analysis, it introduces two additional dimensions: variables and parameters, to allow more effective scoring. These additional dimensions provide the much needed and uniform information that will assist experts with the estimation of probability of occurrence, severity of consequence and safeguards, herein referred to as 3-D methodology. In so doing, it achieves a more systematic approach to risk description and estimation compared to the conventional Risk Priority Number (RPN) of FMECA. Finally, the framework is demonstrated on a real case study of a wave energy converter (WEC) and conclusions of the assessment proved well in comparison and prioritization.

Keywords: Condition-based risk assessment, risk estimation, multi-criteria risk assessment, wave energy converter.

¹ Corresponding author. Tel.: +44 (0) 1234 754631; E-mail address: a.kolios@cranfield.ac.uk

1. Introduction

The establishment of effective safety routines ensures extended and efficient operations, increasing production and lowering levelized cost of energy (LCOE), and consequently increasing the competitive advantage of operators. Defined as “...the ratio of the total cost of the power source to the total energy output over its life...” LCOE forms a commonly used metric to compare the costs of various energy generation technologies. Considering that Capital Expenditure (CAPEX) is distributed over a larger production output, as a result of more efficient management lower LCOE holds the key to a significant increase in return on investment (ROI).

Generally, cost of safety processes such as Inspection, Repair and Maintenance (IRM) for offshore energy structures is abysmally high compared to those in onshore locations. An effective maintenance plan deploys the limited resources to target the most urgent failure modes [1,2] but such decision-making is difficult as it is hard to predict what would be the consequences of a decision, especially when it involves high risk and large uncertainties [3]. It is in this context that risk analysis is adopted as an essential decision support tool to anticipate all the uncertainties, study the likely outcome and take a guided decision. Risk analysis techniques identify the possible sources of hazards and quantify/estimate the attributes of likelihood of occurrence, consequence and possibility of detection [4]. The challenge of risk analysis approaches for use as a decision support tool lies in the detail to which it is capable of considering risk contributory factors, the clarity of risk expression and risk-level estimation [5], and the procedure for risk comparison. In situations where there is lack of accurate failure data for use in quantitative analysis, these descriptions are carried out qualitatively by experts who draw from a wealth of long standing experience and common sense in the subject matter to make judgements. However, these judgements suffer linguistic, lexical and informal uncertainties [6,7] such that analyses' conclusions are subjective to the expert and incomparable [8].

Amongst the various solutions proposed by different authors [1,9–11], FMEA is the most widely practised [12–19]. FMEA's simplified semi-quantitative framework possesses the combined advantages of quantitative and qualitative features it uses to describe the risk criteria; *Occurrence* (O), *Severity* (S) of the effect and *Failure detection* (D), and integrates them on a multiplicative scale to give a single-point measure of risk ranking as shown in (1).

$$RPN_i = (O \times S \times D)_i \quad (1)$$

However, use of FMEA is not without its own criticisms. In fact in [20,21], O , S , and D are classified as high (system)-level evaluation criteria, i.e., ones that give low-levels of detail, and end up in top-level estimates of risk level. Such analysis will lead to results that are not only highly subjective but also non-repeatable [8]. Risk level estimation based on *Multiplicative aggregation* models, such as found in Risk Priority Number (RPN), are also criticised in [6], as always giving an inconsistent variance of risk scores. Still on RPN, [22] raises questions on a number of issues, such as – i) the use of the ordinal ranking numbers as numeric quantities (i.e., referring to multiplication), ii) the presence of “holes” constituting a large part of the RPN measurement scale, iii) duplicate RPN values with very different combinations of O , S and D scores, and iv) the high sensitivity to small changes. Figure 1 shows the plot of RPN against frequency of a random combination of O , S and D . Holes are shown as portions of discontinuities between successive RPNs in multiplicative scales. The direct consequence of ‘sensitivity to small changes’ is that errors due to uncertainties associated with the judgement of O , S and D becomes exaggerated. This is demonstrated in (2) and (3). As can be seen in each of the parentheses of (3), the errors in judgement of O , S and D , denoted as δo , δs and δd respectively, are exaggerated when multiplied. These make FMEA analysis results non-repeatable and subjective, and their interpretation problematic.

$$\Delta RPN = [(O + \delta o) \times (S + \delta s) \times (D + \delta d)] - O \times S \times D \quad (2)$$

$$\begin{aligned} \Delta RPN = & (S \cdot \delta o \cdot D) + (\delta s \cdot O \cdot D) + (\delta s \cdot \delta o \cdot D) + \dots \\ & (S \cdot O \cdot \delta d) + (S \cdot \delta o \cdot \delta d) + (\delta s \cdot O \cdot \delta d) \end{aligned} \quad (3)$$

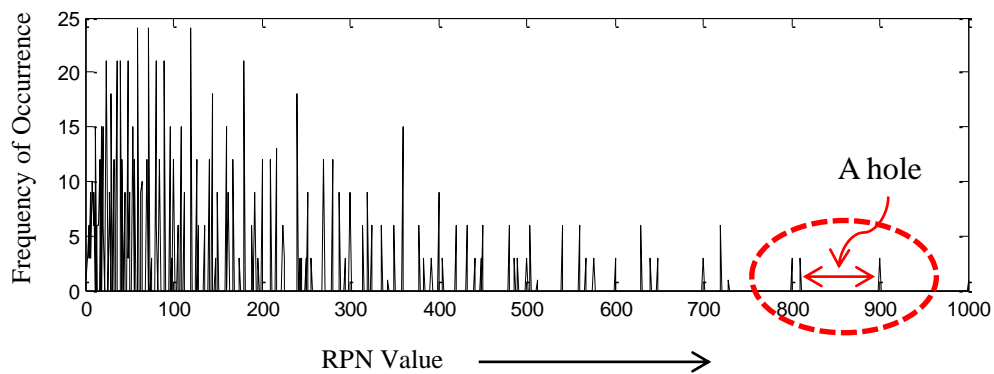

Figure 1 Holes shown in Frequency versus RPN plot

This paper develops a framework for prioritising components of offshore structures based on estimated risk level as a decision support for resource allocation or other forms of intervention action. Because there will always be more failure modes to mitigate than there are resources available, this makes the framework a cost-effective risk management tool. The basic assumptions of the proposed framework are that: *a)* risk exposure is a listing of failure modes, variables and parameters, *b)* the components are exposed differently to different risk sources, *c)* failure results from a combination of the listed failure modes/mechanism, and *d)* that any two or more assessors given detailed information on the conditions of exposures will arrive at the same conclusions on frequency of failure, severity of consequence and “provision of safe guards” for each component.

The above assumptions are actually part of the rationale behind the model. Most known risk analysis method follow this assumption of finite listing of failure modes/mechanisms, variables and parameters, whereas in reality, the listing is infinite. This is one of the shortcoming of risk analysis ideology as a whole because it is not the known failure modes/mechanisms, variables and parameters that is the problem, but rather the unknown ones. This is why continuous study of risk is encouraged. The second assumption describes the structure of the model to accommodate cases where the components are exposed to the same risk. In such case the performance scores of the components under the rest of risk sources not considered is set at zero. The third assumption sets the limits of the methodology to generic failure modes/mechanisms highlighting that not-known risks should also be included in the analysis through following a similar rationale as the one developed for the generic ones. Finally, reproducibility of the methodology is a key enabler of this method as it allows to overcome some of the key barriers of traditional risk assessment methods.

Efforts are concerted on achieving a more systematic expression/description and estimation of risk for different components under different failure modes/mechanisms. Though expressions of risk description and estimation broken down to low-levels of detail make risk assessment and decision making process cumbersome, however, it further helps clear areas of uncertainty and most importantly provides documented evidence for arriving at operational decisions, thus reducing errors due to subjectivity. It is in this context that Multi-Criteria Decision Analysis (MCDA) is often employed to handle issues of incomplete information and to facilitate systemic understanding. As part of the required analytical steps, the elicited scores, with parameters’ weight are aggregated to derive an index for rank-ordering. These

are demonstrated on the real case study of a wave energy converter (WEC). Furthermore, the concept of Safeguard is introduced (expanding the concept of Detection in FMEA) to represent existing failure mitigating measures, recognising the fact that the extent of risk due to a specific failure mechanism is dependent on the availability and efficiency of relevant safeguards.

2.0 A Framework for Condition-based Risk assessment model

2.1 Understanding risk

To describe the concept of risk, as used in this context, imagine any source of injury or harm (hazard) to assets, personnel, image etc., and an activity (or inactivity) involving that source. By risk analysis, an attempt is made to envision how the future will develop; it attempts to anticipate; *i* –what can go wrong? *ii* –how likely is it to happen?, and *iii* –if it does happen, what are the consequences’ severity? *iv* –what provisions can be put in place to prevent or mitigate the consequence and/or consequence escalation? The first question is interpreted as – all the probable failure mechanisms and hazardous events, f_i . Kaplan [23] answers the second question by imagining a thought experiment in which the proposed course of action or inaction is undertaken M – number of times in which scenario f_i occurred m times. Then the frequency of scenario f_i can be estimated based on simple mathematics of calculation of probability, $\phi_i = (m/M)_i$. In situations where there is not enough data or the experiment is resource intensive, ϕ_i expands to probability distribution over ϕ_i , $p(\phi_i)$. In this text, both ϕ_i and $p(\phi_i)$ will be referred to as occurrence O . The third question is about the expected consequences and severity of embarking on the action or inaction, S . The final question refers to the identified measures to prevent, mitigate the consequences and/or consequence escalation. This will be denoted as G_s .

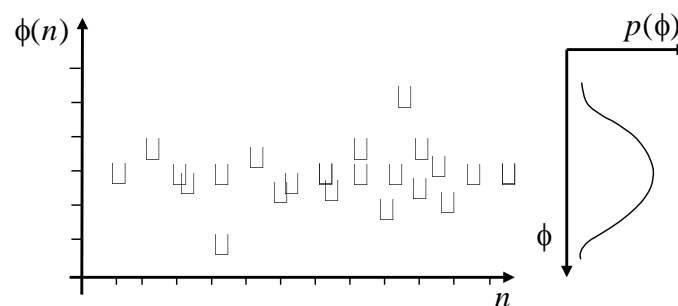

Figure 2 Frequency (ϕ) and probability of frequency, $p(\phi)$

Complete answers to these questions will contain a set of all the scenarios, probability of frequency (or just frequency) and measures of damages as well as safeguards as shown in (4). This is referred to as risk.

$$R = \begin{pmatrix} f_1 & O_1 & S_1 & G_1 \\ f_2 & O_2 & S_2 & G_2 \\ \vdots & \vdots & \vdots & \vdots \\ f_i & O_i & S_i & G_i \\ \vdots & \vdots & \vdots & \vdots \\ f_N & O_N & S_N & G_N \end{pmatrix} \quad (4)$$

2.2 Description of Framework

The methodology proposed in this paper fundamentally consists of elements of risk assessment i.e., identification, analysis and evaluation of hazard sources [4]. The contribution is the systematic approach, depth of analysis and complexity of the systems to which the method is being applied. The framework shares some common features with FMEA in that risk is described by O , S and D . However, unlike the latter, it introduces the concept of *Safeguard Gs* and further provides more details to assist the Decision Maker (DM) in judgement of these risk descriptors. Variables (x) and Parameters (p) are defined giving in-depth information on physical, operational and environmental conditions of the components necessary for making informed judgement. A “fundament unit” of the evaluation sheet has the structure shown in Figure 3.

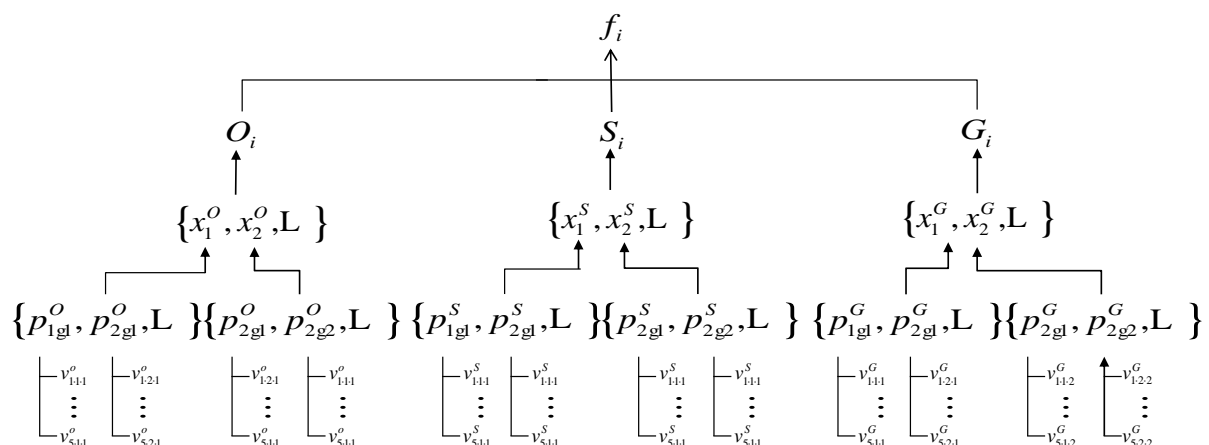

Figure 3 Fundamental unit of analysis model

where x represents the set of variables representing attributes of physical, operational and environmental conditions that influences O , S , and G_s , and p represents different parameters used to qualify x .

As an illustration, consider the threat of external corrosion ($f_i, i = 1$) on an offshore component; one of the variables of Occurrence ($x_j^o; j = 1$) being the “Microbial activity of exposure to environment” can be qualified by parameters, $p_{k,1}^o; k = 1,2,3$, where 1-class of sediment, 2-organic content of sediment, and 3-availability of nitrogen and phosphorous. Each parameter is further qualified by a conditions-based class with each class assigned a marching value in a range of 0 – 5 on the measurement scale [6,20] as shown in Table 1.

The illustration shown in Table 1, using the threat of external corrosion, is only indicative. A comprehensive table covers all the identified threats to components f_i : internal corrosion (INC), threats from welding assembly and construction (WAC), manufacturing defects (MAD), fatigue (FTG), overloading and impact (O&I), third-party damage (TPD), climate and external force (CEF) and incorrect operations (ICO). An example of a typical evaluation sheet is shown in Figure 4. This usually will contain as many fundamental units (Figure 3) as there are failure mode/mechanisms.

Table 1 Illustration of framework for analysis of threat of external corrosion

Variable	Parameter	Wgt	Evaluation criteria	
Microbial activity of exposure environment	Class of Sediment	10	N/A	0
			Sand or rock	1
			Sand-mud	3
			Mud	5
	Organic content of sediment	30	N/A	0
			Low	1
			Medium	3
			High	5
	Availability of Nitrogen and Phosphorous (<i>buried</i>)	20	N/A	0
			Low N&P	1
			Low organic content +N&P	3
			High organic content + N&P	5

Component	f_1									f_2									f_i									
	O_1			S_1			Gs_1			O_2			S_2			Gs_2			O_3			S_i			Gs_i			
	x_{1_1}	x_{2_1}	⋮	x_{1_1}	x_{2_1}	⋮	x_{1_1}	x_{2_1}	⋮	x_{1_2}	x_{2_2}	⋮	x_{1_2}	x_{2_2}	⋮	x_{1_2}	x_{2_2}	⋮	x_{1_3}	x_{2_3}	⋮	x_{1_i}	x_{2_i}	⋮	x_{1_i}	x_{2_i}	⋮	

Figure 4 Layout of assessment spreadsheet

The parameters are usually weighted differently according to importance to the variables and failure modes/mechanisms which they qualify. Different weighting schemes exist; [24–26] show that each scheme is capable of assigning different sets of weights to the parameter set. The overall preference values are significantly influenced by these weights. Care should be taken to ensure that the right weighting scheme is applied to the MCDA technique when finding a solution to the multi-criteria decision problem. In the context in which it is used, weighting refers to the relative importance attached to the information carried by each single parameter of the variable of the failure mode/mechanisms. This should guide the choice of weighting method as the meaning of weighting differ across the various weighting methods. More elaboration has been provided in section 2.4. The ideas developed in this framework are applicable only to structures in the offshore environment and cannot be used out of context.

2.3 Methodology

There are three parts to the 3-D analysis framework: i) information gathering and documentation, ii) Multi-criteria risk analysis (description and estimation and evaluation), and iii) risk aggregation to overall preference value. These are discussed in the following sub-sections.

2.3.1 Database build up: information gathering and documentation

Records of relevant information required for the risk assessment are held in the database. Such information includes assumptions and justification comments that might have been utilised. Databases serve to ensure that the views of the assessor at the time of assessment are captured and documented for future reference and updating. Subsequent assessments of failure mode and mechanisms, variables and parameters, following further

inspection/monitoring data collection can understand quickly the rationale behind the previous ones and modify accordingly. Based on characteristics of the variables, they are classified as belonging to one likelihood of *O*, *S* and *G*s, in a similar way to that used in [27]. More so, it is worthy to mention here that only risk due to progressive failures alone have been considered. Reduction of risk due to accidental failure have to consider the availability of –and effectiveness of –other safety provisions such as emergency exit and evacuation plans.

2.3.2 Multi-criteria risk analysis: description, evaluation and score elicitation

The risks inherent in each component are described in terms of the parameters of the variables of the failure modes/mechanisms. In this framework, risk criteria are constituted by these parameters. Therefore, it is good practice to first get the database ready for application before commencement of evaluation. This ensures consistency of assessment across all components of the infrastructure. Figure 5 shows the steps in the application of a 3-D risk assessment framework.

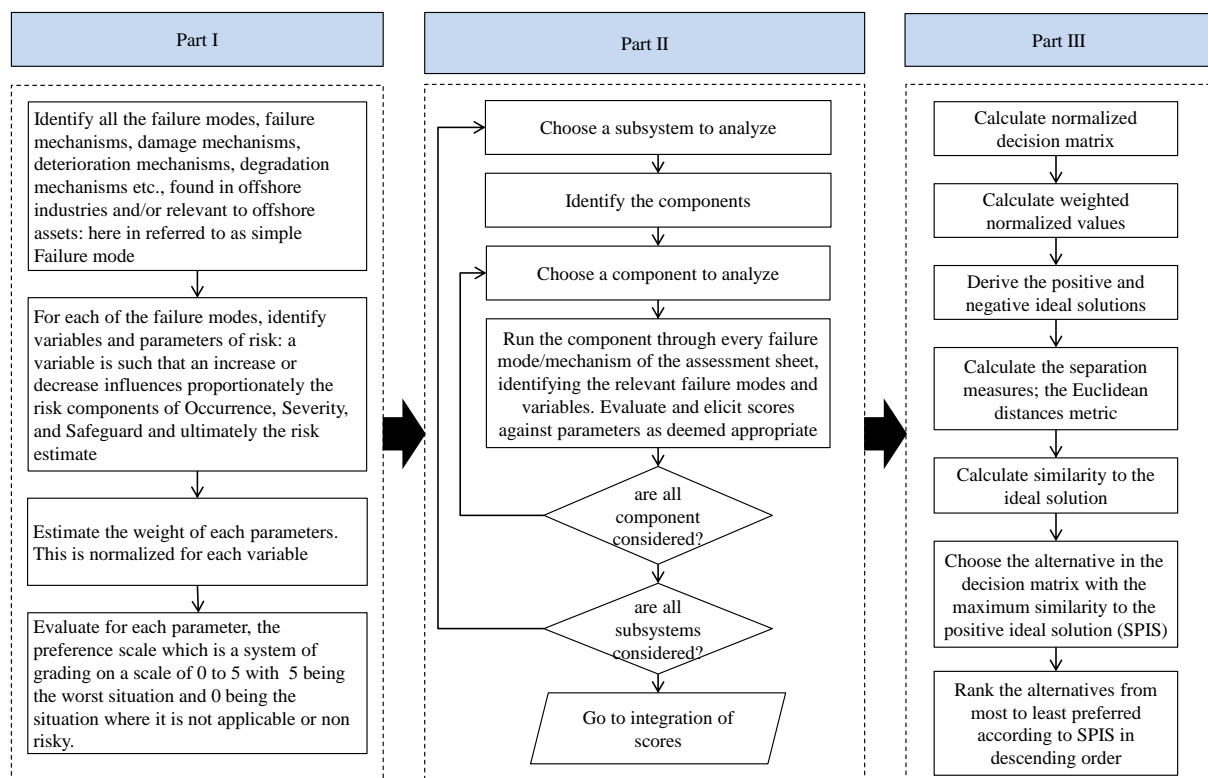

Figure 5 Framework for 3-D risk assessment model

As can be seen from the framework, the first step in the analysis of a structural system is to decompose it into constituent components. These components will perform differently across

various failure modes/mechanisms from a risk perspective. This step is followed by multi-criteria risk analysis of the structural components – i.e., description and estimation of risk from the perspective of different variables (of the failure modes) and elicitation of appropriate parameter –specific *performance scores* (values) based on evaluation against the preference scales [11,28]. The outcome multi-criteria risk analysis is decision matrix V , with rows and columns as components and variables respectively, shown in (5).

$$V = \begin{matrix} & \overline{p_1} & \overline{p_2} & \cdots & \overline{p_n} \\ & \overline{w_1} & \overline{w_2} & \cdots & \overline{w_n} \\ c_1 & \left(v_{11} & v_{12} & \cdots & v_{1n} \right) \\ c_2 & \left(v_{21} & v_{22} & \cdots & v_{2n} \right) \\ \vdots & \left(\vdots & \vdots & \ddots & \vdots \right) \\ c_m & \left(v_{m1} & v_{m2} & \cdots & v_{mn} \right) \end{matrix} \quad (5)$$

Risk evaluation is strongly reliant on judgements by a team of experts drawn from diverse disciplines, such as material, corrosion, inspection, production, maintenance, process etc. It is expected that years of experience, added to provision of detailed information, will better inform experts in making good judgement of O , S and G s.

2.3.3 Score aggregation and ranking

In this step, the parameter-specific *performance scores* are aggregated in a relational way that makes comparison and ranking of the components possible. By aggregating the parameter-specific performance scores, an attempt is made to model failure scenarios, described as listing of, and interaction amongst, failure modes (as well as variables and parameters). Two aggregation approaches are presented in this paper to demonstrate possible treatments of the parameter –specific performance scores in the analysis of failure modes/mechanisms of the fundamental unit(s). As the name implies, a *global aggregation* approach aggregates all parameter-specific performance scores of components across all the fundamental units into a m -dimensional vector of *overall preference value* $[PV]^m$ based on which ranking of the components, m can be done. Each element pv_q of the vector is a solution representing a measure of risk contribution of component; c_q ; ($q = 1,2,3, \dots m$) to the system risk. Notable use of the result of this analysis is identification of the *weakest link* [18]; i.e., the component with highest score of preference value. On the other hand, *local aggregation* is performed at the levels of each fundamental unit (whence the name –local aggregation). This approach

aggregates parameter-specific performance scores of the components –within each fundamental unit – into a m -dimensional vector $[\mathbf{PV}_{fm}]^m$ of *failure mode-specific preference values*. A complete implementation of local aggregation approach will yield a matrix $[\mathbf{PV}_{fm}]^{m \times n}$ of m -components and n -failure mode/mechanisms. Each element of this matrix $pv_{q \times r}$ represents the proportion of risk content of component $C_q; q = 1, 2, \dots, m$, that is contributed by failure mode/mechanism $fm_r; r = 1, 2, \dots, n$.

The difference between the two aggregation approaches can be clearly stated in the following ways; global approach generates a vector $[\mathbf{PV}]^m$ representing system/overall preference values used in risk ranking of the components whereas local aggregation approach results a matrix $[\mathbf{PV}_{fm}]^{m \times n}$ of m -components and n -failure mode/mechanisms. Each element of this matrix $pv_{q \times r}$ represents the proportion of risk content of component $C_q; q = 1, 2, \dots, m$, that is contributed by failure mode/mechanism $fm_r; r = 1, 2, \dots, n$. The result of local integration can be used to support such decisions as “what to mitigate” as well as rationalizing the distribution of the limited resources. It should be noted that it is possible for both analyses to complement each other; however, in the indicative case study used in section 4, the analysis has been performed independently.

2.4 Application of TOPSIS in Multi-criteria risk assessment

MCDA have different types of algorithms for aggregating performance scores and weights of criteria into preference values bases on which the alternatives can be ranked. [30] recommended the use of additive and/or subtractive algorithms as against multiplicative and/or divisive algorithms which disproportionately exaggerate inaccuracies inherent in scores elicitation. A widely used MCDA technique that utilises additive algorithm is TOPSIS (Technique for Ordered Preferences using Similarity to the Ideal Solution) [31,32]. Also called “ideal solution” MCDA, TOPSIS generates preference values that order a set of competing alternatives from the most to least preferred (or desirable) as a function of a multiple criteria. The positive ideal solution A^+ and negative ideal solution A^- , represent hypothetical alternatives that consist of most and least desirable weighted normalized levels respectively of each criterion across the set of competing alternatives. The TOPSIS assumption is that the alternative that is simultaneously closest to the positive ideal solution and farthest from the negative ideal solution performs the best in the set. As can be seen from the two-criterion comparison of alternatives (Figure 6) it is difficult to pick the best from A_1

and A_2 as each happens to possess just one of the necessary qualities. The preference for TOPSIS is because it takes advantage of a wider solution search. TOPSIS' algorithm is able to derive an ideal point and computes Euclidean distances of the alternatives from both positive and negative ideal points.

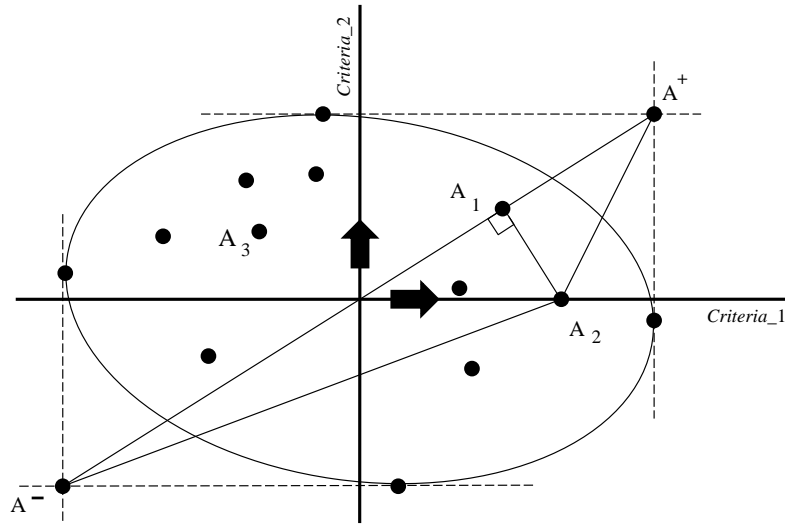

Figure 6 Demonstration of TOPSIS Euclidean distance

The use of TOPSIS in risk analysis of offshore structures stems from a multivariate consideration of failure modes/mechanisms of components towards an estimation of their risk contributions. The selection/judgement of the “highest” risk contributor (or the weak-link) is a process that can be understood and treated under the discipline of MCDA. Similar applications of TOPSIS have been reported in the literature; [33], [34] presented approaches to prioritizing failure modes as an alternative to FMEA; [35–38] presented different approaches to the assessment and selection of support structure configuration for wind turbine projects, while [39]’s approach studied the influence of knowledge background on “risks to the development of tidal energy”. In related applications in the construction industries, TOPSIS has been applied in a risk criticality study and the ranking of a construction object [40,41].

2.4.1 Steps to implementing TOPSIS

In the context used here, evaluation criteria refer to variables and parameters of failure modes. TOPSIS is implemented for the decision matrix $V(5)$ in the following steps.

Step (1): Normalization of decision matrix

The values in the decision matrix of alternatives (5) are normalized based on (6).

$$r_{ij} = \frac{v_{ij}}{\sqrt{\sum_{i=1}^m v_{i,j}^2}}; \quad \begin{matrix} i = 1, 2, 3, \dots, m \\ j = 1, 2, 3, \dots, n \end{matrix} \quad (6)$$

Step (II): Weighted normalized values

$$u_{ij} = w_j \times r_{ij}; \quad i = 1, 2, 3, \dots, m; \quad j = 1, 2, 3, \dots, n \quad (7)$$

Step (III): Derivation of A^ and A^- , the positive and negative ideal solutions*

$$\begin{aligned} A^* &= \{u_1^*, u_2^*, \dots, u_j^*, \dots, u_n^*\} \\ &= \{(\max_i u_{ij} | j \in J_1), (\min_i u_{ij} | j \in J_2) | i = 1, \dots, m\} \end{aligned} \quad (8)$$

$$\begin{aligned} A^- &= \{u_1^-, u_2^-, \dots, u_j^-, \dots, u_n^-\} \\ &= \{(\min_i u_{ij} | j \in J_1), (\max_i u_{ij} | j \in J_2) | i = 1, \dots, m\} \end{aligned} \quad (9)$$

where J_1 is the set of benefit attributes and J_2 is the set of cost attributes.

Step (IV): Calculation of separation measures i.e., n -dim. Euclidean distance metric

The separation from the positive-ideal solution A^* is given by

$$S_i^* = \sqrt{\sum_{j=1}^n (u_{ij} - u_j^*)^2} \quad i = 1, \dots, m \quad (10)$$

The separation from the negative-ideal solution A^- is given by

$$S_i^- = \sqrt{\sum_{j=1}^n (u_{ij} - u_j^-)^2} \quad i = 1, \dots, m \quad (11)$$

Step (V): Calculate similarities to the positive-ideal solution, as follows:

$$0 \leq C_i^* = \frac{S_i^-}{S_i^+ + S_i^-} \leq 1; \quad i = 1, \dots, m \quad (12)$$

Step (VI): Choose the alternatives in the decision matrix with the maximum C_i^* and rank these alternatives from most- to least-preferred according to C_i^* in descending order.

2.4.2 Weighting Method

Weighting plays important role in ordering preferences of alternatives. The interpretation of weight is different for different weighting methods. The weighting method is broadly classified into Subjective and Objective methods [42] and Hybrid method [43]. Subjective weight elicitation is solely the discretion of the DM; however, it may draw inference from the decision matrix. An objective weighting method on the other hand derives weights from the decision matrix by solving a mathematical model and has no dependence on DM. Some examples of popular Subjective weighting methods are; Direct rating, Ranking method, Point allocation, Pairwise comparison –as in Analytical Hierarchical Process(AHP), Ratio method, Swing method, Graphical weighting, Delphi method, Simple multi-attribute ranking technique (SMART). Popular Objective weighting methods are the Entropy method, Criteria importance through inter-criteria correlation (CRITIC), Mean weight, Standard Deviation, Statistical Variance Procedure [42]. In the *direct rating method*, the decision maker is asked to show the importance of each criterion in an ordinal scale. Ranges of scales vary but commonly used ranges are 1-5, 1-7, or 1-10 [44]. This method puts no constraint on the expert's responses, i.e. the weights are not normalized. In addition, the expert has the liberty to adjust the weight of any criterion without altering the values of others. Criteria weighting by Ranking method is carried out in three sub-methods; rank sum, rank reciprocal, and rank exponential [45]. Moving towards class of weighting method known as the direct subjective method, is *Point Allocation* [46]. Here, criteria weight is determined by the decision maker who allocates numbers directly to the criteria from a fixed point to reflect their importance and such that the sum of all the weights equals that fixed point value. It is a very easy method of weighting often adopted for demonstrative purposes only as the weights given by this method are not always precise [42]. This method suits the purpose of this paper which is to demonstrate the proposed risk assessment methodology and is adopted here.

Besides TOPSIS, other MCDA approaches have been applied in risk assessment processes. [47] presented a hybrid model to estimate the weight of risk criteria using AHP which were used in ranking Failure Modes in PROMETHEE. [48] used Measuring Attractiveness by a Categorical Based Evaluation Technique (MACBETH) to categorise critical sources of risk

to ALSTOM power for meditative purposes. [49] presented an approach to the selection of maintenance strategy industrial plants using the Analytical Hierarchical process (AHP). These applications show the resourcefulness of MCDA in engineering decision making.

2.5 Generic Failure Mechanisms of Offshore Energy Structures

This section presents a list of failure mechanisms widely applicable in the offshore energy industry. Records on accidents, incidents, and near misses are valuable industry assets; they form the basis for improvements and advancement in safety. Much of this information is reported in technical papers [7,50–55], and databases such as WOAD and SPARTA [56–62]. Because some failures are induced by incorrect operation, knowledge can be gained about such failures by evaluating practices against relevant standards and recommended practices such as [63–65]. This information is systematically crystallized out and analysed using analysis techniques. At present, there are available collections of possible failure modes/mechanism of offshore energy structures and the underlying factors influencing them. In the development of this paper, many techniques were used to identify offshore failure modes and mechanisms. These included but not limited to, questionnaire survey that targeted foremen and operators of various equipment, experts’ views that targeted consultants and researchers from academia, and business owners. Reports, Standards and Failure databases were also reviewed extensively. The search yielded 23 risk parameters from nine failure modes, as presented in Table 2.

Table 2 Failure Modes, Variables and Parameters

No (i)	Failure Modes and Mechanism (f)	Variables (x)	Parameters (p)
1	External corrosion	1.1-Exposure (Occurrence variable)	1.1.1-Sediment type; 1.1.2-Organic content in sludge; 1.1.3-Organic content in sand; 1.1.4-Water depth; 1.1.5-Availability of N&P; 1.1.6-Background temperature; 1.1.7-Environment of exposure; 1.1.8-Exposure environment (for Concrete); 1.1.9-Temperature of surrounding (for water); 1.1.10-Water resistivity; 1.1.11-Exposure environment chlorine concentration; 1.1.12-Electrical resistivity of concrete; 1.1.13-Splash zone corrosion rate; 1.1.14-Corrosion rate of rebar (Icorr); 1.1.15-Corrosion rate in submerged zone

			and tidal seawater; 1.1.16-External corrosion rate
		1.2-Resistance	1.2.1-Age of assets; 1.2.2-Compressional strength of concrete; 1.2.3-Type of coating.
		1.3-Safeguard	1.3.1-Condition of the coating on concrete; 1.3.2-Adhesion of coating on Structure; 1.3.3-Uniformity of coating condition on Structure, 1.3.4-Condition for the particular coating; 1.3.5-Adherence to established standard for coating repair & Maintenance; 1.3.6-Redundancy; 1.3.7-Interval of Inspection; 1.3.8-Quality of Inspection-Technology; 1.3.9-Quality of Inspection-Inspectors; 1.3.10-Loss of metal; 1.3.11-Assessment of Structural Condition based on visual inspection; 1.3.12-Percentage of assets inspected in the last 5 years; 1.3.13-Established Asset's inspection frequency met; 1.3.14-Failure history
2	Internal corrosion	2.1-Exposure	2.1.1-Product Corrosivity; 2.1.2-Evidence of MIC; 2.1.3-Evidence of Erosion; 2.1.4-Presence of dead-leg; 2.1.5-Corrosion rate; 2.1.6-Percentage loss of metal (ILI).
		2.2-Severity	2.2.1-Effect on Structure health; 2.2.3-Effect on product; 2.2.4-Personnel health and safety; 2.2.5-Effect on environment; 2.2.6-Effect on Image; 2.2.7-Penalty
		2.3-Safeguard	2.3.1-Time since the last inspection ; 2.3.2- Failure History; 2.3.3-System inhibition and/or biocidal; 2.3.4-Cleaning Compliance programme; 2.3.5-Redundancy; 2.3.6-Emergency Control; 2.3.7-Accessibility & Ease of repair
3	Welding, Assembly, & Construction	3.1-Welding	3.1.1-Year of welding; 3.1.2-Certification of quality of the base material; 3.1.3-Weld quality
		3.2-Construction	3.2.1-Design code according to industrial standard; 3.2.2-Filler Material; 3.2.3-Joint type; 3.2.4-Quality of pipe; 3.2.5-Number of repairs during construction

		3.3-Detectability	3.3.1-Percentage compliance of the total number of inspections to be performed in welding ; 3.3.2-Susceptibility of state welds; 3.3.3-Construction defects (dents, bends, notches, marks, folds, etc.); 3.3.4-Qualified and benchmarked repairmen processes; 3.3.5-Quality control and assurance during construction
4	Manufacturing Defects	4.1-Material	4.1.1-Pipe type; 4.1.2-Material; accessories under & conformable with piping class
		4.2-Quality	4.2.1-History of Manufacturing faults; 4.2.2-Material quality certification; 4.2.3-Active features such as foundation type, specification, grade, diameter information etc.
5	Fatigue	5.1-Free span	5.1.1-Evaluate undercuts according to “scour analysis”; 5.1.2-Interaction of the free span
		5.2-Fatigue	5.2.1-Surge/surf; 5.2.2-Susceptibility to fatigue
		5.3-Mitigation	5.3.1-Actions
6	Overloading and Impact	6.1-Operating characteristics	6.1.1-Wind condition during berthing/anchoring; 6.1.2-Currents condition of during berthing/anchoring; 6.1.3-Effect of interns boats (for docks Maritimes only); 6.1.4-Variation of ship draft during docking/anchoring; 6.1.5-Percentage of light weight cargo piles (i.e. under bridges; Pipe Racks) visually inspected in past 5 years; 6.1.6-Percentage of Heavy load piles installed ; 6.1.7-Visually inspected in last 5 years; 6.1.8-Permanent loads; 6.1.9-Variable loads; 6.1.10-Deformations
		6.2-Mitigation measures	6.2.1-Time since last inspection of Piles; 6.2.2-Visual inspection of the safety critical systems; 6.2.3-Repair piles affected by impacts/overload; 6.3.4-Proper functioning of drainage system of Piling docks; 6.3.5-Defence system ensures absorption of impact energy from ships
7	Third Party Damage	7.1-Activity Level	7.1.1-Activity area
		7.2-Mitigation	7.2.1-Patrol; 7.2.2-Depth covered; 7.2.3-Mechanical Protection; 7.2.4-Ballast piping; 7.2.5-Parameters meet DNV OS - F101; 7.2.6-From deep below the water surface to the active third-party damage region

		7.3-Past Records	7.3.1-Analysis of objects falling under Annex PoF impacts party; 7.3.2-Signpost; 7.3.3-Community Education Programme, Communications Plan; 7.3.4-Abnormalities (mechanical damage) detected and sized by ILI; 7.3.5-Annex PoF impacts anchors
8	Climate and external forces	8.1-Scour on Seabed	8.1.1-Debris flows; 8.1.2-Bed depressions due to gas leaks; 8.1.3-Active faults; 8.1.4-Seismic classification according to the NSR-10; 8.1.5-Record of failures due to undercuts; 8.1.6-Stability in the bottom of the sea; vertical stability criterion and two lateral stability criteria
		8.2-Environmental Features	8.2.1-Soil susceptible to liquefaction of sandy strata during seismic events; 8.2.2-Earthworks (landslides, erosion); 8.2.3-Topography and bathymetry conditions; 8.3.4-Heavy rains; Tides; 8.3.5-Hurricane history
9	Incorrect operations	9.1-Safeguards	9.1.1-There are established operating procedures and system maintenance; 9.1.2-There are operators trained in using procedures; 9.1.3-History of failure caused by incorrect operations; 9.1.4-Audits; 9.1.5-Actions taken in accordance with the audit findings

3.0 Case study of Wave Energy Converter systems

The case study used in this work as a reference application is a prototype Wave Energy Converter (WEC) located in Dawanshan Island in Guangdong Province, China and operating at a water depth of 28m, and maximum tidal range of 2.5m at the point of deployment.

3.1 Overview of WEC System function

The physical boundaries and functional integration of the WEC are delineated by the block diagram as shown in Figure 7.

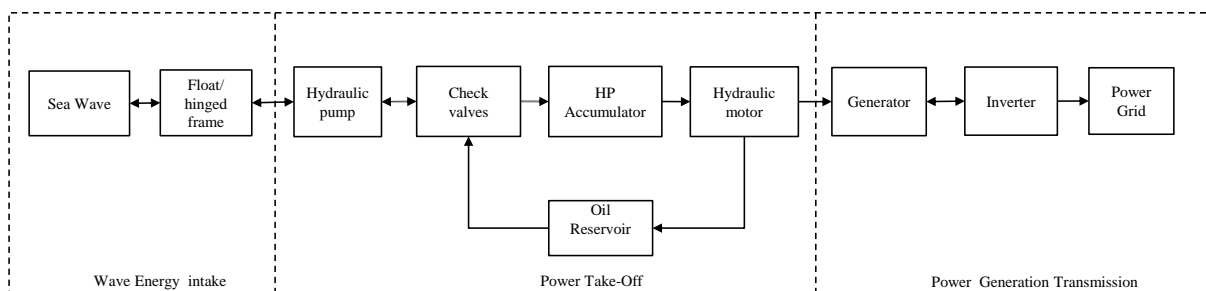

Figure 7 A Simplified Block diagram of a Wave Energy Converter

WEC abstracts energy potential from the sea waves and makes it available to primary users in the form of electric power through a series of electromechanical conversion processes. The energy acquisition system is a hemispherical shaped buoy suspended at the tip end of a hinged frame. When intercepted by an incident wave, the buoy heaves while the frame observes a revolutive motion about an axis (of revolution). The frame itself is held in position by an arm fixed to the stationary ship, as shown in Figure 8. The revolution of the frame causes a linear reciprocating motion of the double-acting rod of a hydraulic cylinder which in turn pumps fluid to the hydraulic motor generator set, through a high pressure gas accumulator and network of steel pipes. Low-energy hydraulic oil drains into the reservoir where the oil are temporarily stored and have their remaining residual energy dissipated as heat before being returned to the cylinder.

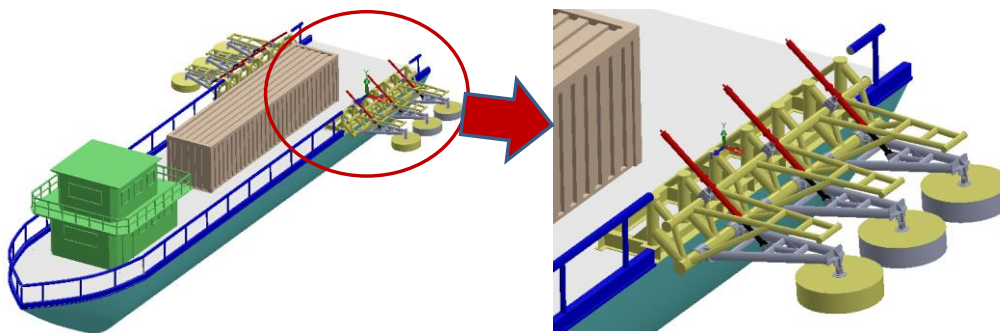

Figure 8: Wave Energy Converter

3.2 Analysis of selected subsystems of a WEC

Floating buoy: A floating buoy develops a buoyant force which induces a heave motion [66]. Wave buoys and boats operate in a similar environment and are made of similar material (carbon fibre reinforced composites) which should have similar failure modes. Slamming of waves on the buoy causes overload and impacts which can cause fractures. Poor fabrication (manufacturing defects) reduces the resistance to loads and makes the structure susceptible to fatigue loads. Buoys can suffer cracks in the laminated skin seen where the gel coat has fractured. The impact of waves on stiff buoys also causes fractures and holing.



Figure 9: A fractured buoy (courtesy of Wave Star Energy)

Hinged frame: The hinged frame performs a revolute motion about the (upper) revolute joint (Figure 10B) of the fixed arm extending from the ship and driving a double-acting rod of the hydraulic cylinder bolted to lower the revolute joint. The frame is hollow and made of mild carbon steel and operates in the splash zone. This implies that a high rate of internal and external corrosion is likely. This however, could be aggravated by biofouling.

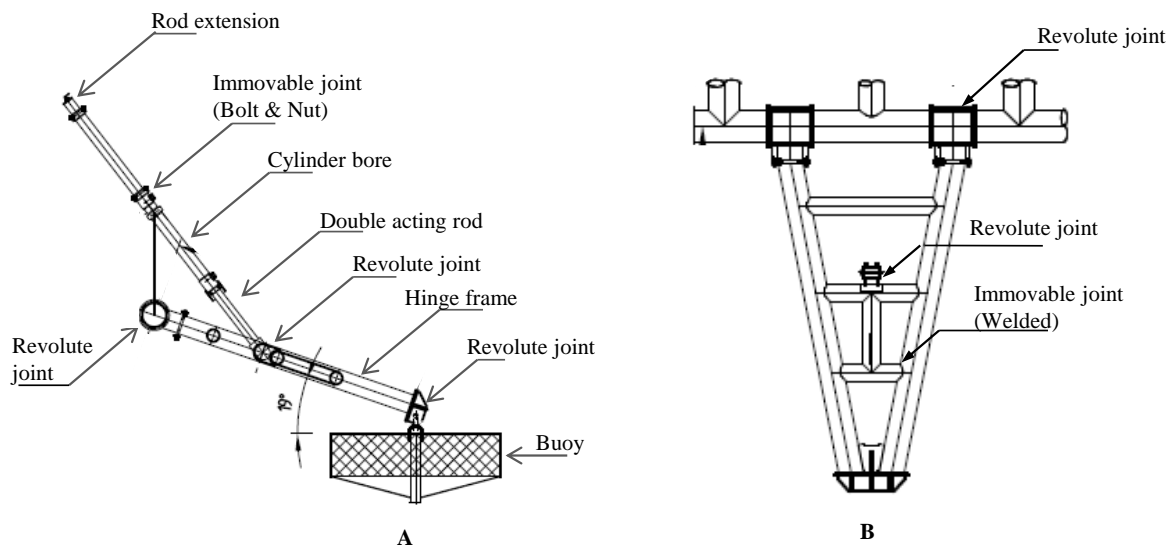

Figure 10 A wave energy converter: (A) general description, (B): Hinged frame

In addition, failure could possibly be initiated in the hinged frame due to welding/assembly/construction activities and/or defects suffered during manufacturing, fatigue, overloading and impact, and the possibility of third-party damage from fishing trawlers etc.

Hydraulic cylinder and double-acting rod: The rod observes translational reciprocating motion about the cylinder bore. This pumps oil to the hydraulic motor. The rod is a 40 Ni-Cr plated material, manufactured and tested based on DIN ISO 6022. Being that Ni-Cr alloy is highly resistant to corrosion, implies that the rod is least susceptible to corrosion attack,

however, there is the possibility of buckling under slamming waves due to overloading or impact. Figure 11 shows a schematic of a hydraulic cylinder.

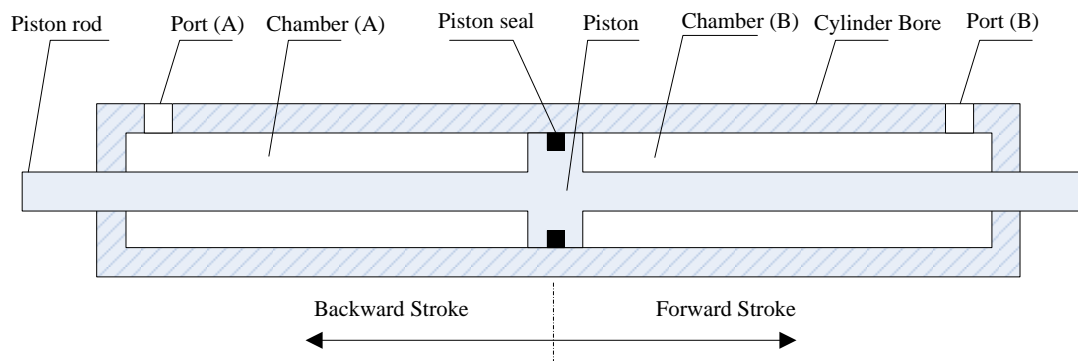

Figure 11 Longitudinal cross-section of double-rod double-acting cylinder

Other damages common to these structures, as reported in [67] are due to O-rings, cracking of glands, damage to bearings and seals. These damages are associated with misalignment of the load (e.g., bent rod). They cause poor clearances through which leakages can occur. Another cause of poor clearance is bad assembly. A split weld around the base and ports of cylinders is another damage feature commonly observed. These are caused by stress-increasing mechanisms, such as fatigue, and/or stress-induced, such as manufacturing defect, welding, assembly and construction. There is the possibility of fracture from being operated beyond recommended conditions. Such mechanisms are considered here under “Incorrect operation”. Lastly, contamination of the hydraulic fluid by seawater, and corroded, eroded or worn out parts, such as the end cap can potentially cause failure in delivering the hydraulic fluid to the motor. This has a root cause as wrong operations are usually from wrong filter size or operating at a high case pressure.

Motor and Generator: The hydraulic cylinder transfers the fluid at high pressure to the motor which turns the turbine. The major failure modes of motor and generator are highlighted in studies by [68–70]. They include but not restricted to, excessive leakage, seal failure and noise. At a component level the failure modes are identified as follows; corrosion (in winding and magnets), spalling, wear (in bearing and blades), overload - impact (seal, blade, shaft and bearing), adjustment error during welding assembly, construction and/or manufacturing leading to misalignment of shaft, rotor asymmetry, bearing shells and/or roller element, fatigue as experienced in shaft, slip ring and blade.

Pipeline: The pipeline serves as a channel through which hydraulic fluid moves from the cylinder to the motor-generator set. This may suffer crack or burst (in the worst cases) due to overloading and impact. The occurrence of these failure modes could be further aggravated by internal and/or external corrosion at a rate that is influenced by parameters such as ambient temperature and moisture content, corrosivity of hydraulic fluid etc. Fatigue may result from dynamics associated with fluid flowing in a pipe or from vibration due to assembly error, i.e., too big a clearance, resulting in misalignment and mostly caused by errors in welding, assembly and construction and/or manufacturing defects.

Gas accumulator: The gas accumulator is used to maintain stability of flow by keeping the pressure of the pipeline at the required level. In bladder-type gas accumulators, the flexible bladder holds the compressible gas at the pre-charged pressure and may rupture in the event of overloading or impact during pre-charging or an out-of-proportion reduction in system pressure. Other causes of rupture are incorrect compression ratio, incorrect pre-charge pressure [71] which are all incorrect operations. Fatigue failure may also be experienced in the spring and poppet assembly of the gas accumulator.

Valves: A pattern can be drawn between type of valve and failure. However, reference is made here of generic types as found in [72–74]. Valves used in hydraulic systems, such as a WEC to control behaviour of the hydraulic fluid, are of three types; Pressure valve, Flow valve and Directional valve. Valve faults such as abrasion and wear usually have, as a causal factor, improper assembly which creates uneven loading and tilting of the valve-plate. Valves may experience other failures, such as internal corrosion, erosion, valve defects, mechanical failure, fatigue and wear. Mechanical failure results from actions such as welding, assembly and construction, and incorrect/defective/improper operational procedures (such as wrong specification, human factor). It is very common to expect incorrect operation where manufacturing and material defects are observed, where in fact, the problem is not the valve itself but something that has been done to affect the valve operation. This is said to constitute 50% of the causes of valve incidents [72].

3.3 Demonstration of Implementation of 3-D framework

This section demonstrates the implementation of the 3-D framework, as documented in section 2, on a real system of a WEC. A single variable – microbial activity level in the sediment – of the threat of external corrosion (Table 2) is used for demonstrative purposes in

order to illustrate the concept of parameters and variables. Table 3 shows the performance of the components of a WEC exposed to microbial activity. Score has been elicited according to current conditions of the variables. The weights of the criteria are derived by the point allocation method [42]. In a more detailed assessment, it is recommended that a more robust method such as AHP [34,75–77] be used in determining the weights. The evaluation was carried out by a team of five experts involved in the WEC project and drawn from Cranfield University, UK and the National Ocean Technology Center, Tianjin, China. Each of the components of the WEC had been assessed under the parameters and had scores assigned to them as provided by the evaluation scale.

Table 3 Evaluation based on one variable of external corrosion

Variable	Parameters	Weight (%)	Evaluation scale		Components list																							
					Wave buoy	Hinge frame			Hydraulic cylinder					Pipeline	Hose	Valve	Accumulator			Motor and Generator								
						Frame	Revolute joint	Weld joint	Piston	Cylinder	Rod	Seal	Bearing				Bladder	Spring	Poppet	Bearing	Blade	Shaft	Magnet	Winding	Seal			
Microbial activity level in sediment	Class of Sediment	15	Mud	5	5	5	4	4	3	3	2	3	2	4	5	4	2	0	0	2	2	2	0	0	0	3		
			Sand-mud	3																								
			Sand or rock	1																								
			Not applicable	0																								
	Organic content in sediment (sludge)	20	If mud	High	3	2	2	2	0	0	0	0	0	0	0	0	0	0	0	0	0	0	0	0	0	0	0	0
				Medium	2																							
				Low	0																							
			If sand	High	5																							
				Medium	3																							
				Low	2																							
	Water depth	15	Superficial (<200 ft)	5	5	5	5	5	0	0	0	0	0	0	0	0	0	0	0	0	0	0	0	0	0	0	0	0
			Deeper (>200 ft)	2																								
			Not applicable	0																								
	Availability of Nitrogen and Phosphorous	20	High organic content+ N&P	5	5	5	5	5	0	0	0	0	0	0	2	2	0	0	0	0	0	0	0	0	0	0	0	0
			Low organic content + N&P	2																								
Low N&P			0																									
Background Temperature	30	> 10 °C	5	2	2	2	2	5	5	5	5	5	5	2	2	5	5	5	5	5	5	5	5	5	5	5	5	
		< 10 °C	2																									
		Not applicable	0																									

The set of positive-ideal, A^+ and negative-ideal, A^- solutions as derived for the normalized decision matrix from (8) and (9) respectively are:

$$A^* = \{0.014, 0.051, 0.035, 0.039, 0.017\} \quad (13)$$

$$A^- = \{0.000, 0.003, 0.001, 0.001, 0.007\} \quad (14)$$

Measures of separation from positive and negative ideal solutions as derived from (10) and (11) respectively are:

$$S_i^* = \{0.010, 0.010, 0.011, 0.050, 0.071, 0.071, 0.071, 0.071, 0.071, 0.071, 0.065, 0.065, 0.071, 0.072, 0.072, 0.071, 0.071, 0.071, 0.072, 0.072, 0.071\} \quad (15)$$

$$S_i^- = \{0.072, 0.072, 0.072, 0.052, 0.013, 0.013, 0.012, 0.013, 0.012, 0.015, 0.020, 0.019, 0.012, 0.010, 0.010, 0.012, 0.012, 0.012, 0.010, 0.010, 0.013\} \quad (16)$$

The similarity to both S^+ & S^- solutions is computed as given in (12).

$$C_i^* = \{0.874, 0.874, 0.870, 0.512, 0.157, 0.157, 0.141, 0.157, 0.141, 0.175, 0.238, 0.222, 0.141, 0.126, 0.126, 0.141, 0.141, 0.141, 0.126, 0.126, 0.157\}. \quad (17)$$

The risk performance indices for the different components are expressed in (17). This is presented in bar chart form in Figure 12.

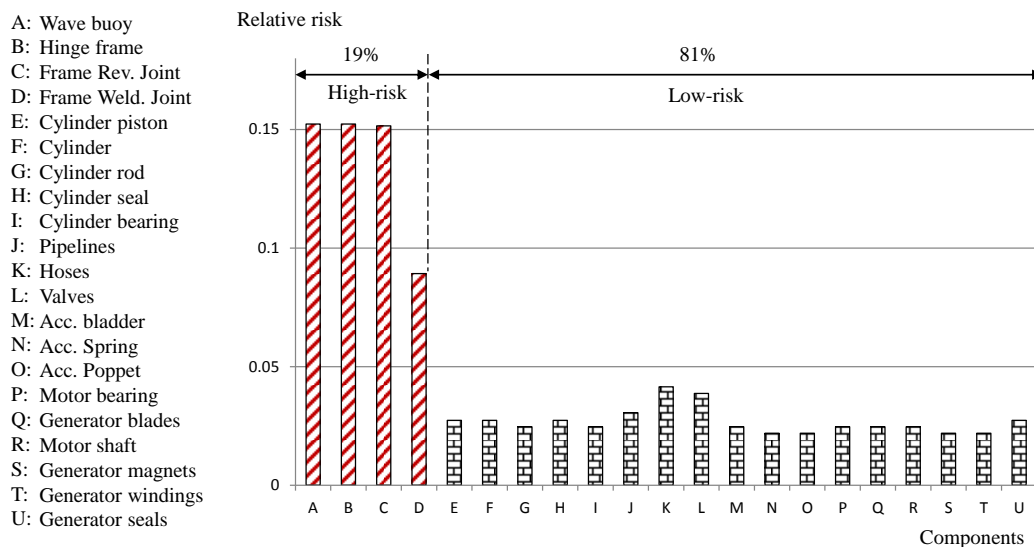

Figure 12 Risk performance indices for different component from exposure to microbial induced external corrosion

It can be deduced from Figure 12 that 54% of the risk of external corrosion due to activities of microbial activities lies in just 19% of the components. These components are: wave buoy and the frame, and the two joints. The results of a full scale implementation of the framework on the structure and incorporating variables from all the threats and failure modes will be presented in the next section.

4.0 Result and Discussion

A total of 21 components of the WEC were analysed and evaluated against 112 parameters of the nine generic failure mechanisms. Figure 13 shows the results of the *global aggregation* approach i.e., the plot of $[PV]^m$ as described in 2.3.3. It can be seen from Figure 13 that about half of the system's risk is concentrated in just 23% of the components: Generator components –seals, generator's windings and magnet, motor shaft, and generator blade. The implication of this from an IRM perspective is that it would be inefficient to inspect, repair and maintain all components with the same level of priority. Rather, a recommended IRM plan should identify the 23% of components and raise their priority level.

The result obtained from full implementation of local aggregation approach; the matrix $[PV_{fm}]^{m \times n}$ (see section 2.3.3) is presented in Table 4. The plotted of these values are as shown in the scatter of Figure 15. It shows the relative activity levels of various failure modes/mechanisms in each component. As can be seen from Figure 15, errors from welding-assembly-construction (WAC) constitutes the active threats to components wave buoys, hinge frame, revolute joints(frame), frame welds, and cylinder piston. From IRM point of view, these threats should be inspected in those components. Similarly, the first three active failure modes/ mechanisms for pipeline (component J) are MAD, INC, and error of WAC. The threats that develop through these failure modes/mechanisms should be monitored through inspection. Another way the data of Table 4 can be treated is to perform row –sum which gives the total risk content of the components. This gives an interesting pattern when normalised (Figure 14) that captures the distributions of failure mode/mechanism –specific risks for each component of the system. This analysis avails the assets manager/engineer the knowledge of susceptibility of the various components of the asset to the failure mode/mechanisms; the results which will serves as a supports tool to the asset manager/engineer who may be required to defend maintenance decisions from time to time such as setting priority of failure mode to mitigate for each component.

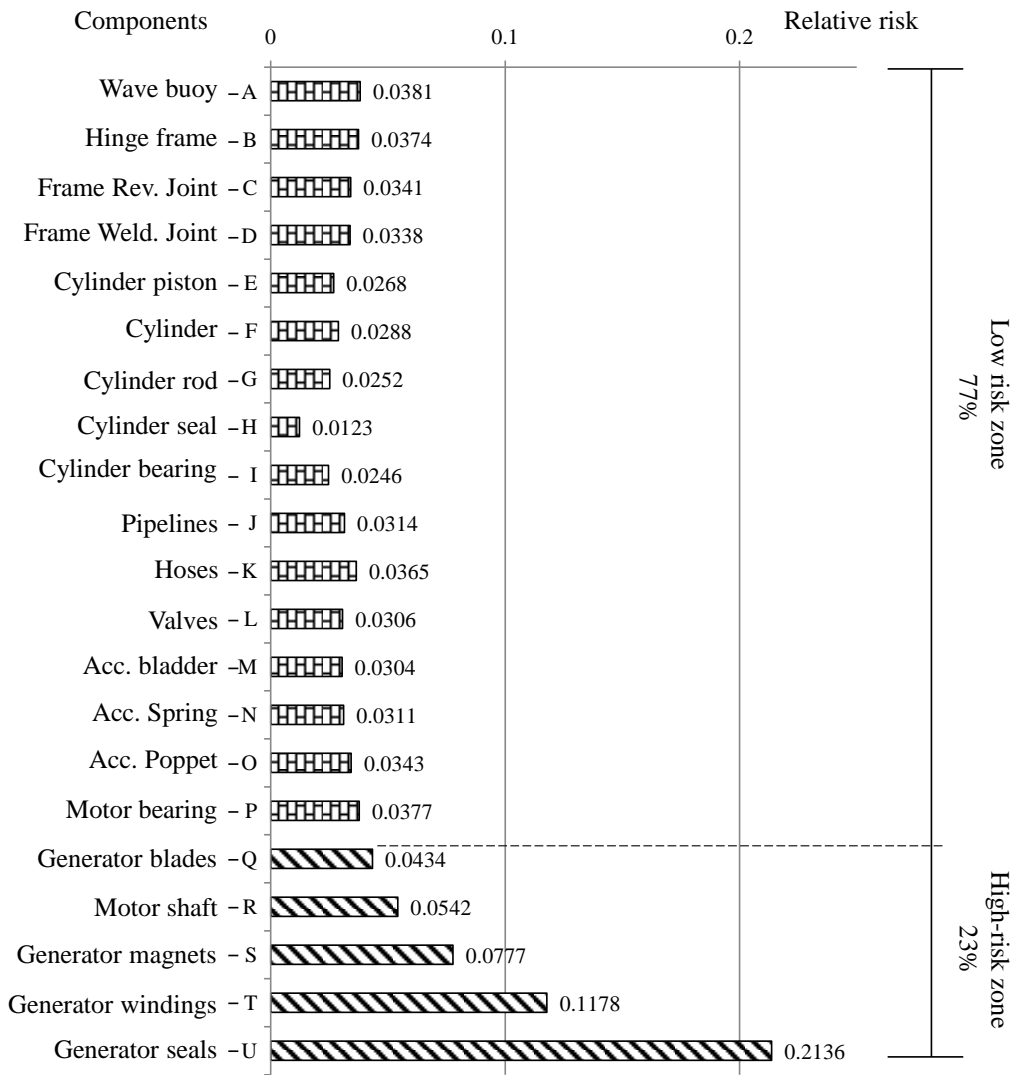

Figure 13 Distribution of Risk in a WEC system

Table 4 Performance of the components under Failure modes

Component	Risk sources and Events								
	INC	ETC	WAC	MAD	FTG	O&I	TPD	ICO	CEF
Wave buoy	0.3717	0.6109	0.9857	0.1024	0.7154	0.3365	0.6470	0.4967	0.8651
Hinge frame	0.3802	0.6117	0.9942	0.4503	0.5449	0.4364	0.6454	0.4967	0.3737
Frame Rev. Joint	0.2930	0.6109	0.9848	0.1646	0.3885	0.2123	0.6454	0.4965	0.4305
Frame Weld Joints	0.2927	0.6109	0.9866	0.2178	0.7099	0.3899	0.6454	0.4949	0.3737
Cylinder piston	0.0819	0.2603	0.9995	0.1634	0.3764	0.1401	0.3127	0.1702	0.4531
Cylinder	0.1963	0.1152	0.0682	0.0890	0.3680	0.4757	0.5827	0.1702	0.4080
Cylinder rod	0.1650	0.1246	0.5677	0.1537	0.4580	0.3281	0.5828	0.1702	0.3087
Cylinder seal	0.1465	0.1204	0.5111	0.0859	0.3756	0.4103	0.3222	0.1702	0.1910
Cylinder bearing	0.0746	0.1465	0.5120	0.0890	0.1975	0.4380	0.3897	0.1702	0.1349
Pipeline	0.7573	0.1263	0.7436	0.7797	0.5286	0.4399	0.3582	0.1702	0.3087
Hoses	0.7881	0.2061	0.5482	0.5799	0.7658	0.5276	0.5702	0.5572	0.3737
Valve	0.6955	0.2199	0.5500	0.3197	0.4644	0.1679	0.0786	0.1605	0.3087
Accumulator Bladder	0.0637	0.0168	0.5110	0.2170	0.4580	0.5878	0.0103	0.1605	0.0713
Accumulator Spring	0.0652	0.1022	0.2587	0.3197	0.5815	0.2470	0.0103	0.1605	0.1349
Poppet	0.0652	0.1004	0.5142	0.3230	0.5936	0.3863	0.0103	0.1605	0.0000
Motor Bearing	0.0750	0.4204	0.5122	0.1577	0.2846	0.4413	0.1015	0.5082	0.0713
Generator blades	0.0736	0.4202	0.5539	0.1635	0.0668	0.1562	0.0103	0.5082	0.0000
Motor shaft	0.1424	0.4202	0.6334	0.5803	0.5594	0.7289	0.0103	0.5035	0.1349
Generator magnet	0.0512	0.0164	0.5099	0.0265	0.3885	0.2041	0.0103	0.1605	0.0713
Gen. Windings	0.1359	0.0913	0.5099	0.3207	0.1538	0.2876	0.0103	0.1605	0.0000
Motor seals	0.0759	0.1011	0.5101	0.0276	0.5815	0.4297	0.1015	0.1605	0.0713

INC = Internal corrosion; ETC = External corrosion; WAC = Welding, Assembly, and Construction; MAD = Manufacturing defect; FTG = Fatigue; O&I = Overloading & Impact; TPD = Third party damage; ICO = Incorrect operation; CEF = Climate & External forces

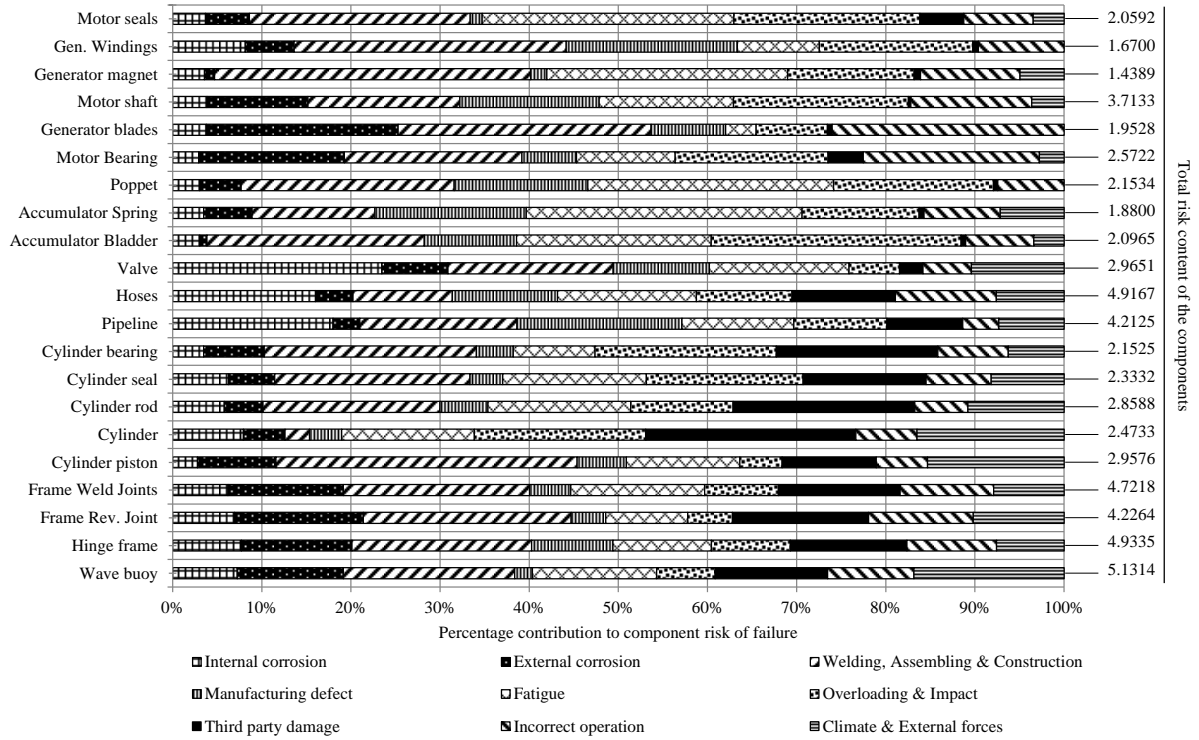

Figure 14 Normalized sum of component's failure mode-specific risk score

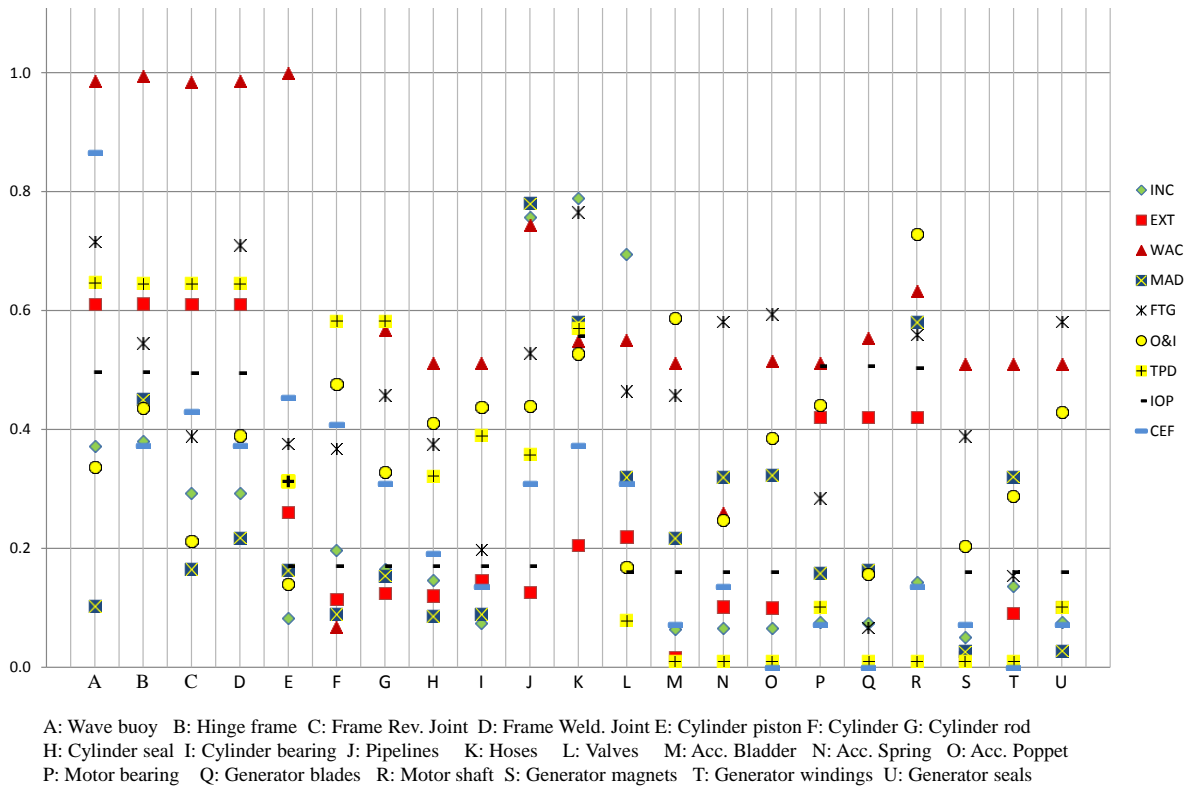

Figure 15: Contribution of failure modes towards components risk

5 Conclusions

In this paper, a framework is developed to support prioritisation of components of offshore engineering systems based on risk levels for intervention action, leading to inspection, repair and maintenance. The advantage of this framework is the systematic way it incorporates a wide range of evaluation criteria and still demonstrates clarity in risk level estimation, aggregation and prioritisation in a manner that ensures repeatability. Precision of ranking is enhanced through a combination of actions; firstly, an updatable database is developed for failure modes, risk variables and parameters. These parameters hold information on operating conditions –normal and/or upset, current and projected future of the components, required in order to make informed judgement of occurrence, severity of failure modes and safeguards. This enhances the traceability of the assessment outcomes to the source data. The direct implication of this is that the model can easily be updated with the latest information as obtained from inspection findings. Also, it addresses epistemic uncertainties and ensures uniformity of application during the evaluation process. Secondly, it minimizes subjectivity in risk evaluation through consideration of weighting at parameters levels – which qualify the variables of failure modes. This is in contrast to the practice in FMEA where weights are considered at the failure mode level resulting in a high subjective model. For demonstrative purposes, these weights had been derived through a point allocation process. Thirdly, it provides a systematic way of application of risk assessment across components of complex engineering systems such that is possible to perform risk assessment of different components simultaneously with a lower risk of subjectivity, and reduced inaccuracy.

The framework has been implemented on a real offshore structure, a WEC, and the results obtained showed to have practical implications to efficient IRM management of components of offshore energy structures. Initial prioritisation of components by *global aggregation approach* is usually based on previous inspection records. Subsequent prioritisation requires up-to-date information via inspections finding that target prioritised components. If a component shows no sign of developing defect – by maintaining the same relative position in the priority scale for recurring inspection – it should be credited by increasing the time to the following inspection. In other words, the question of “*how often to inspect*” is addressed. More so, the efficiency of IRM can be further enhanced by suggesting “*what to inspect*”. This is where the second analysis –*local aggregation approach* –finds application. A scatter plot

of $[PV_{fm}]^{m \times n}$ (Figure 15) shows the failure modes/mechanisms arranged in order of decreasing activity level. This result is vital for defence of decisions on budget allocations for inspection repair and maintenance.

For the case study presented, it should be noted that the result is validated based on the experience of the participating researchers in the project. This is due to the fact that the area of renewable energy is relatively new, as such there are not enough data for validation. Though an attempt is made in this paper to list as many failure mode/mechanism and variables and parameters as possible, such analysis inherently is performe finite; whereas in reality such list is infinite. However, the model is highly flexible in terms of accommodating new found failure modes/mechanisms, variables and parameters and can be adapted for many purposes. Identification and inclusion of new failure modes/mechanisms, variables and parameters as more knowledge is gained is dependent on the experience assessor.

Acknowledgements: This work was supported by grant EP/M020339/1 for Cranfield University, from the UK Engineering and Physical Sciences Research Council (EPSRC).

6.0 References

- [1] Linares P. Multiple Criteria Decision Making and Risk Analysis as Risk Management Tools for Power Systems Planning. IEEE Trans Power Syst 2002;17:895–900.
- [2] Sakai S. Risk-based Maintenance. East Japan Railw Co 2010:29–44.
- [3] Aven T, Vinnem JE, Wiencke HS. A decision framework for risk management, with application to the offshore oil and gas industry. Reliab Eng Syst Saf 2007;92:433–48. doi:http://dx.doi.org/10.1016/j.res.2005.12.009.
- [4] ISO. Risk management – Code of practice and guidance for the implementation of BS ISO 31000. 2011.
- [5] Linkov I, Satterstrom FK, Kiker G, Batchelor C, Bridges T, Ferguson E. From comparative risk assessment to multi-criteria decision analysis and adaptive management: Recent developments and applications. Environ Risk Manag - State Art

- 2006;32:1072–93. doi:<http://dx.doi.org/10.1016/j.envint.2006.06.013>.
- [6] Pluessa DN, Grosob A, Meyer T. Expert Judgements in Risk Analysis: a Strategy to Overcome Uncertainties. *Chem Eng* 2013;31.
- [7] Bea RG. Risk Assessment and Management: Challenges of the Macondo Well Blowout Disaster. 2011.
- [8] Geary W. Risk Based Inspection: a Case Study Evaluation of Offshore Process Plant. vol. HSL/2002/2. Sheffield: Health and Safety Laboratory; 2002.
- [9] Chan HK, Chan FT. A comprehensive survey and future trend of simulation study on FMS scheduling. *J Intell Manuf* 2004;15:87–102.
- [10] Heller S. Managing industrial risk—Having a tested and proven system to prevent and assess risk. *Pap Present 2004 Annu Symp Mary Kay O'Connor Process Saf Cent Pap Present 2004 Annu Symp Mary Kay O'Connor Process Saf Cent* 2006;130:58–63. doi:<http://dx.doi.org/10.1016/j.jhazmat.2005.07.067>.
- [11] Garvey PR. Analytical methods for risk management.pdf. Bedford, Massachusetts, USA: CRC Press; 2009.
- [12] BS EN 60812. Analysis techniques for system reliability Procedure for failure mode and effects analysis (FMEA). London: British Standards Institute; 2006.
- [13] Mikulak R, McDermott R, Beauregard M. The basics of FMEA. 2nd ed. New York, NY 10016: Taylor & Francis; 2011.
- [14] Moore, W, H., and Bea, R G. Management of Human Error in Operations of Marine Systems, Report No, HOE-93-1, Final Joint Industry Project Report. California, Berkeley: 1993.
- [15] Bea RG. Quantitative and Qualitative Risk Analyses - The Safety of Offshore Platforms. *Offshore Technol Conf* 1996. doi:10.4043/8037-MS.
- [16] Stamatis, D.H. Failure Mode and Effect Analysis: FMEA from Theory to Execution. 2003. doi:10.2307/1268911.
- [17] Lipol LS, Hag J. Risk analysis method:FMEA/FMECA in the organizations. *Int J*

- Basic Appl Sci 2011;11:74–82.
- [18] Carlson C. Effective FMEAs: Achieving safe, reliable economical products and processes using failure mode effect and analysis. Hoboken, New Jersey, USA: Wiley and sons inc.; 2012.
- [19] Wang Y, Cheng G, Hu H, Wu W. Development of a risk-based maintenance strategy using FMEA for a continuous catalytic reforming plant. *J Loss Prev Process Ind* 2012;25:958–65.
- [20] Marlow DR, Beale DJ, Mashford JS. Risk-based prioritization and its application to inspection of valves in the water sector. *Reliab Eng Syst Saf* 2012;100:67–74. doi:<http://dx.doi.org/10.1016/j.ress.2011.12.014>.
- [21] Hodges S, Spicer K, Barson R, John G, Oliver K, Tipton E. High level corrosion risk assessment methodology for oil & gas systems. NACE Int. Corros. 2010. Conf. Expo, San Antonio, TX, USA.: NACE International; 2010, p. 1–15.
- [22] Bowles JB. An assessment of RPN Prioritization in a Failure Modes Effect and Criticality Analysis. *Annu. Reliab. Maintainab. Symp.*, Tampa, FL. USA: IEEE; 2003, p. 380.
- [23] Kaplan S, Garrick BJ. On the quantitative definition of risk. *Risk Anal* 1981;1:11–27.
- [24] Hobbs BF. A Comparison of Weighting Methods in Power Plant Siting. *Decis Sci* 1980;11:725–37. doi:10.1111/j.1540-5915.1980.tb01173.x.
- [25] Hobbs BF. What can we learn from experiments in multiobjective decision analysis? *IEEE Trans Syst Man Cybern* 1986;16:384–94.
- [26] Weber M, Borcherding K. Behavioral influences on weight judgments in multiattribute decision making. *Eur J Oper Res* 1993;67:1–12. doi:10.1016/0377-2217(93)90318-H.
- [27] Pugsley AG. Report on Structural Safety. London, UK: 1955.
- [28] Franceschini F, Galetto M. A new approach for evaluation of risk priorities of failure modes in FMEA. *Int J Prod Res* 2001;39:2991–3002.
- [29] Linkov I, Seager TP. Coupling multi-criteria decision analysis, life-cycle assessment,

- and risk assessment for emerging threats. *Environ Sci Technol* 2011;45:5068–74. doi:10.1021/es100959q.
- [30] Reaves CC. *Quantitative research for the behavioral sciences*. New York, USA: John Wiley; 1992.
- [31] Hwang CL, Yoon K. *Multiple attribute decision making*. 1981. *Lect Notes Econ Math Syst* 1981.
- [32] Zeleny M. *Multiple criteria decision making*. New York, USA: McGraw-Hill; 1982.
- [33] Sachdeva A, Kumar D, Kumar P. Multi-factor failure mode critical analysis using TOPSIS. *J Ind Eng* 2009;5:1–9.
- [34] Kutlu AC, Ekmekçioğlu M. Fuzzy failure modes and effects analysis by using fuzzy TOPSIS-based fuzzy AHP. *Expert Syst Appl* 2012;39:61–7. doi:10.1016/j.eswa.2011.06.044.
- [35] Kolios A, Collu M, Chahardehi A, Brennan FP, Patel MH. A multi-criteria decision making method to compare support structures for offshore wind turbines. *EWEC Warsaw* 2010.
- [36] Lozano-Minguez E, Kolios AJ, Brennan FP. Multi-criteria assessment of offshore wind turbine support structures. *Renew Energy* 2011;36:2831–7. doi:http://dx.doi.org/10.1016/j.renene.2011.04.020.
- [37] Kolios AJ, Rodriguez-Tsouroukdissian A, Salonitis K. Multi-criteria decision analysis of offshore wind turbines support structures under stochastic inputs. *Ships Offshore Struct* 2014:1–12.
- [38] Martin H, Spano G, Küster JF, Collu M, Kolios AJ, Spano G, et al. Application and extension of the TOPSIS method for the assessment of floating offshore wind turbine support structures 2012. doi:10.1080/17445302.2012.718957.
- [39] Kolios A, Read G, Ioannou A. Application of Multi-Criteria Decision Making to Risk Prioritization in Tidal Energy Developments. *Int J Sustain Energy* 2013;http://www:1–17.
- [40] Zavadskas EK, Turskis Z, Tamošaitiene J. Risk assessment of construction projects. *J*

- Civ Eng Manag 2010;16:33–46. doi:10.3846/jcem.2010.03.
- [41] Tamosaitience J, Zavadskas EK, Turskis Z. Multi-criteria risk assessment of a construction project. *Procedia Comput Sci* 2013;17:129–33. doi:10.1016/j.procs.2013.05.018.
- [42] Zardari NH, Ahmed K, Shirazi SM, Yusop Z Bin. *Weighting Methods and Their Effect on Multi Criteria Decision Making Model Outcomes in Water Resources Management*. Malaysia: Springer; 2015.
- [43] Wang JJ, Jing YY, Zhang CF, Zhao JH. Review on multi-criteria decision analysis aid in sustainable energy decision-making. *Renew Sustain Energy Rev* 2009;13:2263–78. doi:10.1016/j.rser.2009.06.021.
- [44] Nijkamp P, Rietveld P, Voogd H. *Multicriteria Evaluation in Physical Planning*. Groningen: Elsevier Science Publishers; 1990.
- [45] Malczewski J. *GIS and Multicriteria Decision Analysis*. John Wiley & Sons, Inc.; 1999.
- [46] Mardle SJ. *Energy Decisions and the Environment: A Guide to the Use of Multicriteria Methods*. vol. 53. 2002. doi:DOI 10.1057/palgrave.jors.2601379.
- [47] Maheswaran K, Loganathan T. A novel approach for prioritisation of failure modes in FMEA using MCDM. *Int J Eng Res Appl* 2013;3:733–9.
- [48] Figueiredo MS, Oliveira MD. *Prioritizing Risks Based on Multicriteria Decision Aid Methodology: Development of Methods Applied to ALSTOM Power*. Ind. Eng. Eng. Manag., Hong Kong: IEEE; 2009, p. 1568–72.
- [49] Bevilacqua M, Braglia M. The analytical hierarchy process applied to maintenance strategy selection. *Reliab Eng Syst Saf* 2000;70:71–83.
- [50] Moan T. The Alexander L. Kielland accident-30 year Later. Proc 1st Wallace Lect Rept MITSC 81-8, Sea Grant Coll Program, Dept Ocean Eng MIT Cited Moan, Torgier *Int J Offshore Polar Eng* 1981;17:1–21.
- [51] Paé-Cornell ME. Learning from the Piper Alpha accident: A postmortem analysis of technical and organizational factors. *Insur Math Econ* 1993;13:165. doi:10.1016/0167-

6687(93)90921-B.

- [52] Bea GR. Accident on 25 July 2000 at La Patte d'Oie in Gonesse (95) to the Concorde registered F-BTSC operated by Air France (English translation). vol. f-sc000725. France: Ministry of Equipment, Transportation and Housing-Bureau of Investigation and Analysis for the Safety of Civil Aviation; 2002.
- [53] Nivolianitou Z, Konstandinidou M, Michalis C. Statistical analysis of major accidents in petrochemical industry notified to the major accident reporting system (MARS). *J Hazard Mater* 2006;137:1–7. doi:<http://dx.doi.org/10.1016/j.jhazmat.2004.12.042>.
- [54] NASA Safety Center. The Case for Safety: The Case for Safety. *Syst Fail Case Stud* 2013;7:11–44.
- [55] Graham B, Reilly WK, Beinecke F, Boesch DF, Garcia TD, Murray CA. *Deep Water: The Gulf Oil Disaster and the Future of Offshore Drilling*. 2011. doi:10.3723/ut.30.113.
- [56] WOAD. *Worldwide Offshore Accident Databank* 2016.
- [57] International Association of Oil and Gas Producers. *Risk Assessment Data Directory: Major accidents*. 2010.
- [58] HSE Oil & Gas UK. *Accident Statistics for Offshore Units on the UKCS 1990-2007*. vol. part 1. 2009.
- [59] Oil and Gas UK. *Health & Safety Report 2014*. 2014.
- [60] Ian S, Ukcs W, Recovery M, Report F. Report by Sir Ian Wood UKCS Maximising Recovery Review: Final Report 2014:1–18.
- [61] SINTEF. *OREDA-Offshore Reliability Data Handbook*. 4th ed. OREDA Participants; 2002.
- [62] Catapult & Crown Estate. *SPARTA: System Performance, Availability and Reliability Trend Analysis* n.d. <https://www.sparta-offshore.com/spartaweb/login> (accessed 1 January 2016).
- [63] API 581. *Risk-Based Inspection Technology* 2008.

- [64] CEN. Risk-Based Inspection and Maintenance Procedures for European Industries (RIMAP). vol. CWA 15740: Rue de Stassart, Brussels: European Committee for Standardisation; 2008.
- [65] API. RP 571, Damage Mechanisms Affecting fixed Equipment in the Refining Industry. 2003.
- [66] SI Ocean. Ocean Energy: State of the Art. EU Proj Rep 2012:79. http://si-ocean.eu/en/upload/docs/WP3/Technology_Status_Report_FV.pdf. (accessed 18 October 2015).
- [67] Wallis KW. The Top 10 Reasons for Hydraulic Cylinder Failures - And What To Do About Them 2010. <http://ezinearticles.com/?The-Top-10-Reasons-for-Hydraulic-Cylinder-Failures---And-What-To-Do-About-Them&id=5474641> (accessed 19 October 2015).
- [68] Tchakoua P, Wamkeue R, Ouhrouche M, Slaoui-Hasnaoui F, Tameghe TA, Ekemb G. Wind Turbine Condition Monitoring: State-of-the-Art Review, New Trends, and Future Challenges. *Energies* 2014;7:2595–630.
- [69] Grimwade J, Hails D, Robles E, Salcedo F, Bard J, Kracht P, et al. Review of Relevant PTO Systems. D2.03. 2012.
- [70] BS 5760-5. Reliability of systems, equipment and components. Part 5. Guid to Fail Modes, Eff Crit Anal (FMEA FMECA) 1991.
- [71] Casey B. How to Avoid Hydraulic Accumulator Failure. *Hydraul Supermarket.com* 2014. <http://www.hydraulicsupermarket.com/blog/all/how-to-avoid-hydraulic-accumulator-failure/>.
- [72] Peters J. Assessment of valve failures in the offshore oil & gas sector. 2003.
- [73] Geary W. Failure analysis of solenoid valve components from a hydraulic roof support. *Case Stud Eng Fail Anal* 2013;1:209–16. doi:10.1016/j.csefa.2013.07.004.
- [74] Casey B. How to Solve and Prevent Hydraulic Problems. *Hydraul Com* 2005. <http://www.hydraulicsupermarket.com/books> (accessed 29 October 2015).
- [75] Seçme NY, Bayrakdaroğlu A, Kahraman C. Fuzzy performance evaluation in Turkish

Banking Sector using Analytic Hierarchy Process and TOPSIS. *Expert Syst Appl* 2009;36:11699–709. doi:<http://dx.doi.org/10.1016/j.eswa.2009.03.013>.

- [76] DAgkinis I, Theodoros L, Nikitakos N. Operational failure prevention methodology for offshore systems using multiple criteria decision-making process. *J Polish Saf Reliab Assoc* 2012;3:15–22.
- [77] Perera N, Sutrisna M. The Use of Analytic Hierarchy Process (AHP) in the Analysis of Delay Claims in Construction Projects in the UAE. *Built Hum Environ Rev* 2010;3:29–48.