

Accepted Manuscript

Prospects of deployment of Jatropha Biodiesel-fired Plants in Nigeria's power sector

Tosin Onabanjo Somorin, Athanasios J. Kolios

PII: S0360-5442(17)31151-9
DOI: 10.1016/j.energy.2017.06.152
Reference: EGY 11160
To appear in: *Energy*
Received Date: 10 November 2016
Revised Date: 22 June 2017
Accepted Date: 26 June 2017

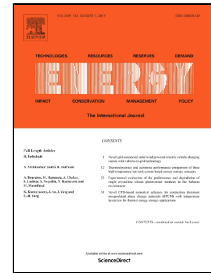

Please cite this article as: Tosin Onabanjo Somorin, Athanasios J. Kolios, Prospects of deployment of Jatropha Biodiesel-fired Plants in Nigeria's power sector, *Energy* (2017), doi: 10.1016/j.energy.2017.06.152

This is a PDF file of an unedited manuscript that has been accepted for publication. As a service to our customers we are providing this early version of the manuscript. The manuscript will undergo copyediting, typesetting, and review of the resulting proof before it is published in its final form. Please note that during the production process errors may be discovered which could affect the content, and all legal disclaimers that apply to the journal pertain.

Prospects of deployment of *Jatropha* Biodiesel-fired Plants in Nigeria's power sector

Tosin Onabanjo Somorin, Athanasios J. Kolios

Cranfield University, Cranfield, MK43 0AL, UK

*Corresponding Author:

Tosin Onabanjo Somorin,

School of Water, Energy and Environment

Cranfield University, Cranfield, Bedfordshire, MK43 0AL United Kingdom

Email: t.o.onabanjo@cranfield.ac.uk

1 **ABSTRACT**

2 This paper presents the techno-economic performance analysis of *Jatropha* biodiesel-fired power plants in comparison
3 with natural gas- and diesel-fired plants. *Jatropha* biodiesel can be substituted for natural gas in industrial gas turbines at
4 a slight loss in power output of ~2% and plant efficiency of ~1%. The exclusive use of the fuel in heavy duty industrial
5 gas turbines is not economically viable at existing electricity generation prices in Nigeria, except fuels are restricted to
6 combined cycle engines and considered as biomass power plants. The Levelized Cost of Electricity (LCOE) of the
7 *Jatropha* biodiesel-fired plants varied from \$0.203-0.252/kWh, values that are below the cost of self-generated electricity
8 (SGE) in Nigeria —\$0.45-0.70/kWh. To integrate *Jatropha* biodiesel into existing power plants, a minimum production-
9 based incentive (PBI) of \$0.052-0.082/kWh can be provided for up to nine years or maximum partial fuel substitution
10 (PFS) of 33-40% can be mandated, depending on the mode of operation. A guaranteed fuel price of \$0.18-5/gallon can
11 be ensured, depending on electricity contract price. A carbon tax up to \$100/tCO₂ can also be imposed on natural gas-
12 fired plants, but this does not ensure economic viability. The high cost of SGE in Nigeria uncovers an opportunity for
13 embedded power generation.

14

15 **Keywords:**

16 *Jatropha curcas*, embedded power generation, gas turbines, diesel engines, self-generation, cost of electricity

17

LIST OF ABBREVIATIONS

CCGT	Combined Cycle Gas Turbine
CF	Capacity Factor
COT	Combustor Outlet Temperature
DPR	Department of Petroleum Resources
ECN	Energy Commission of Nigeria
FIT	Feed-in Tariff
GHG	Greenhouse Gas
HP	High Pressure
HRSG	Heat Recovery Steam Generator
ISO	International Standards Organization
LCOE	Levelized Cost of Electricity
LHV	Lower Heating Value
LMP	Larson-Miller Parameter
LP	Low Pressure
NAPIMS	National Petroleum Investment Management Services
NERC	Nigerian Electricity Regulatory Commission
NGC	Nigerian Gas Company
NIPP	National Integrated Power Project
NNPC	Nigerian National Petroleum Corporation
NPE	Net Plant Efficiency
NPO	Net Plant Output
NPV	Net Present Value
NREEEP	National Renewable Energy and Energy Efficiency Policy
OCGT	Open Cycle Gas Turbine
PFS	Partial Fuel Substitution
PBI	Production-Based Incentive
PPMC	Petroleum Products Marketing Company
REP	Renewable Energy Programme
SMD	Sauter Mean Diameter
SME	Small-Medium Enterprise
SGE	Self-Generated Electricity
SPB	Simple Payback Period
TLCC	Total Life Cycle Cost
UNFCC	United Nations Framework on Climate Change
UNDP	United Nations Development Programme
URCF	Uniform Capital Recovery Factor
WACC	Weighted Average Cost of Capital

18 **1. INTRODUCTION**

19 Energy is a crucial factor for the development and growth of any economy. It is the driving force behind the strong
20 industrial and technologically advanced economies and a missing element in poorly advancing economies. In Nigeria,
21 more than 90 million people (~55% of the population) do not have access to grid electricity [1] and less than 20% of the
22 country's energy demand is supplied by the national grid [2]. It is typical for a power station to operate below nominal
23 installed capacity —average plant availability as low as 9% was reported in Oyedepo [3]. Consequently, residents and
24 industries are forced to depend on SGE or suffer the adverse effects of severe power outages, crippling costs of power
25 supply and persistent blackouts.

26 According to the National Bureau of Statistics, 70.7% of businesses own or share a generator while 25.7% of households
27 have generators [4]. The lack of access to grid electricity was the second highest barrier to businesses, as some companies
28 spend about 50% of their income on fuelling generators [5]. The Manufacturers' Association of Nigeria estimated that 60
29 million Nigerians own power generating sets and spend ₦1.6 trillion (\$10.4 billion) on fuel annually [6]. Based on
30 aggregate statistics from the United Nations Commodity Trade [7], the value of imported electric generators is averaged
31 at about \$1 billion every year. This makes Nigeria the leading importer of decentralized electric generators in Africa. In
32 reality, these data could be an underestimation, as some households and businesses have more than one generator to
33 ensure electricity availability [8]. These conditions are linked to deteriorating generation, transmission and distribution
34 sectors, as well as to factors such as fuel shortages, inadequate gas-networks, frequent vandalism of pipelines, poor
35 maintenance and delayed infrastructure development. The large imbalance between demand and supply of energy is
36 therefore, Nigeria's greatest economic bane and requires both emergency solutions and long term development. In these
37 instances, biodiesels could be a valuable and renewable substitute for fossil-derived fuels.

38 Biodiesels are “fuels composed of fatty acid methyl or ethyl esters and obtained from vegetable oils or animal fats” [9].
39 They are produced by thermochemical conversion of triglycerides to fatty acid methyl or ethyl esters using an alcohol-
40 catalyst dependent reaction, known as transesterification [10]. They are derived from a wide range of sources including
41 common and readily available feedstocks such as palm oil [11], rapeseed [12], animal fats [13] and non-edible feedstocks
42 such as *Jatropha curcas* [14] and *Miscanthus giganteus* [15]. These fuels have gained importance in recent years [16-17];
43 however, their adoption is limited by socio-economic and environmental concerns, as well as cost related factors. *Jatropha*
44 biodiesels are of interest in Nigeria because the crop —*Jatropha curcas* from which the oil is derived— grows naturally
45 in Nigeria [18] and has perceived environmental and socio-economic benefits [19]. *Jatropha* farming is yet to be practised
46 commercially and there is little information on the cultivation of the crop in Nigeria; however, the crop is planned to be
47 farmed along the 5000 km oil pipelines and engendered for power generation. Its use in Nigeria's power sector is identified
48 as a means to diversify the country's energy mix. It is also recognized as a way of bringing about economic growth and

49 development, including increased employment, income, livelihoods and community involvement, and private investment
50 for communities involved in its production. As such, the economic feasibility of Jatropha biodiesel-fired plants will be a
51 useful information source for early developments of biomass power generation in Nigeria.

52 In the literature, there is broad consensus that biodiesels and their blends have a direct application in internal combustion
53 engines [20-22]. Studies conducted on stationary diesel engines show that biodiesels can replace conventional diesel fuel
54 and achieve similar engine performance, as an alternative, without major engine modification —extensive reviews are
55 provided by Xue *et al.* [23] and Dwivedi *et al.* [24]. In industrial gas turbines, engines are increasingly designed to operate
56 using a wide range of fuels and properties, but natural gas is typically used. The use of diesel fuels is less common in gas
57 turbines, except for start-up and as emergency back-up, and there is sparse information on the application of biodiesels.
58 A few of the studies conducted with biodiesels in gas turbines are highlighted below: Hashimoto *et al.* [21] investigated
59 the combustion characteristics of palm biodiesel in comparison to conventional diesel fuel and observed a similar range
60 of adiabatic flame temperatures over a wide range of excess air ratios. Both fuels had similar ignition and combustion
61 performance, but palm biodiesel had less tendency to form luminous flame and soot. Liu *et al.* [22] showed that the
62 biodiesel derived from recycled cooking oil had higher dynamic viscosity and caused bigger fuel droplet sizes, particularly
63 at lower pressure. Their study also showed that the biodiesel had a lower flame temperature and combustor pressure drop,
64 and overall good ignition performance, which was dependent on the choice of air-assist pressure selected for ignition.
65 Sallevelt *et al.* [25] suggest the importance of preheating biodiesels to improve spray quality and combustion performance,
66 especially for highly viscous fuels. Relatively poor atomization quality and longer evaporation rates were observed by
67 Bolszo *et al.* [26] during the use of soy biodiesel in a 30 kW gas turbine engine. Recommendations were made to optimize
68 fuel atomization by adjustment of the fuel injection system. Combustion studies [27-28] carried out over a range of
69 operating conditions using biodiesels in heavy duty and aero-derivative gas turbines (GE Frame 6B, 7EA and LM6000)
70 indicate lower emissions than baseline values.

71 In Jatropha-specific studies, Rehman *et al.* [29] showed that there is a similarity in the performance characteristics of a
72 44 kW gas turbine test rig when operated with Jatropha and diesel oils. The reduction of viscosity of Jatropha oils by
73 degumming or esterification was proposed. Similar analysis by Badami *et al.* [30] using Jet-A, Jatropha biodiesel, gas-
74 to-liquid kerosene and a blend of Jatropha biodiesel and Jet-A fuel in a small turbo-jet engine, demonstrated that only a
75 slight difference exists in the fuel mass flow rate of Jatropha biodiesel and Jet A. This difference was consistent with and
76 proportional to the reduction in lower heating value (LHV) of the blended fuel. Combustion and spray characteristics of
77 high viscous Jatropha oils by Fan *et al.* [31] demonstrate the need for efficient atomization. Their studies proposed the
78 use of assisted air supply in addition to pressure-swirl atomizer at liquid viscosity exceeding 7 mm²/s. Combustion studies
79 by Hashimoto *et al.* [32] using Jatropha oil and biodiesel in a combustion chamber with conditions comparable to a gas

80 turbine and employing an air-assist pressure swirl atomizer showed that flame radiation intensity and soot emissions
81 decrease with increasing biofuel mixing ratio for both fuels. The reduced soot emission was a function of the Sauter Mean
82 Diameter (SMD) and achieved at an optimum fuel temperature. Onabanjo et al. [33] showed that there is positive net
83 energy balance from the use of Jatropha biodiesels in industrial gas turbine engines. These studies present the potential
84 application of biodiesel fuels and oils in gas turbines but little is known about the cost implications.

85 Economic analyses including life cycle cost assessments of Jatropha biodiesel fuels and applications have been largely
86 focused on the production costs of biodiesels. In this regard, Van Eijck *et al.* [34] showed that the cost of production of
87 Jatropha biodiesel was higher than diesel fuel in Tanzania, Mali and India, values varying from \$13-25/GJ of fuel. These
88 costs were found to differ from country to country and mainly affected by poor product yield, high wage rate, labour
89 requirements and cost of converting the oil to biodiesels. Similar studies by Openshaw [35], Sampattagul *et al.* [36] and
90 Wegstein *et al.* [37] showed that the cost of production for Jatropha biodiesel is slightly higher than the retail price of
91 diesel fuels but that these costs improved over time. Parajuli [38] proposed a 20% blend of Jatropha biodiesel in Nepal
92 for successful integration of biofuels, using a levelized cost of production analysis. Quintero *et al.* [39] and Felix *et al.*
93 [40] showed that production costs for Jatropha biodiesel can vary from \$0.6-0.95/L while Yusuf and Kamarudin [41] and
94 Tewfik *et al.* [42] estimated values within the range, \$0.3-0.8/L. These studies are limited to cost of fuel production and
95 none of the above has examined the economic feasibility of Jatropha biodiesel-fired plants.

96 Thus, from a technical point of view, can Jatropha biodiesel be used in place of conventional diesel and natural gas for
97 power generation in Nigeria, without compromising generation efficiency? Is the use of Jatropha biodiesel as a renewable
98 substitute for conventional diesel and natural gas economically feasible in Nigeria? What economic scenarios can allow
99 the integration of Jatropha biodiesel into power generation without compromising technical and economic performance?
100 This study proposes the use of Jatropha biodiesel for power generation in Nigeria and as a renewable substitute for diesel
101 fuels. A comparative thermodynamic performance analysis coupled with economic assessment was conducted using two
102 engine configurations (open and combined cycle) to complement the emerging use of industrial gas turbines in the
103 National Integrated Power Project (NIPP) in Nigeria. The study compares the use of Jatropha biodiesel in these engines
104 with two conventional fuels (natural gas and conventional diesel) to highlight the potential for its use in a low-carbon
105 policy environment. The results are compared with the average cost of SGE and the regulated wholesale electricity
106 generation (contract) prices in Nigeria. The study concludes by exploring different economic mechanisms of integrating
107 Jatropha biodiesel without compromising a plant's economic viability.

108

109 2. METHOD

110 2.1. TECHNICAL ANALYSIS

111 This study models a generic independent power project in Olorunsogo, Nigeria and assumes the power station possesses
112 four heavy-duty simple cycle gas turbines with or without combined cycle capabilities. Engines were simulated at
113 International Standard Organization (ISO) standard temperature and pressure conditions using Aspen Plus®(v9), a
114 process optimization software that allows the design, integration and optimization of complex chemical processes. The
115 open cycle gas turbine (OCGT) was modelled as a single shaft gas generator (i.e. compressor, combustor and a turbine
116 coupled to an electric generator) —Figure 1. The combined cycle gas turbine (CCGT) includes two OCGT engines laid
117 in a 2-2-1 configuration with heat recovery steam generators (HRSGs) and a steam turbine —Figure 2. Here, the waste
118 heat from the exhaust of the topping cycle (i.e. gas generator) was recovered in the dual pressure HRSGs, and the resulting
119 steam was expanded up to condenser pressure by the bottoming cycle (i.e. steam turbine). The condensate was then
120 pumped to a deaerator where it was recycled for heat recovery and utilization.

121 The above processes were modelled using mass flow streams (i.e. air and fuel) and unit operation blocks. The heat
122 exchange processes in the high-pressure (HP) and low-pressure (LP) economizer, evaporator and super heater were
123 modelled using HEATX blocks, while the deaerator and drums were simulated using FLASH2 blocks. The fuel
124 combustion process was modelled using the RGIBBS reactor for chemical and phase equilibrium calculations, since the
125 reactor achieves Gibbs free energy minimization without design considerations. The gas generator was limited to a
126 maximum firing temperature of 1084°C irrespective of fuel type, since modern engines possess multiple control systems
127 such as water or steam injection modes, adjustable inlet guide vanes, bleed valves, variable stator vanes and fuel control
128 actuators, to limit firing temperature, reduce the impact of high temperatures on metal rotor blades, ensure emission
129 compliance and to preserve the life of engine components.

130 Fig. 1: Simplified flow diagram of the open cycle gas turbine

131 Fig. 2: Simplified flow diagram of the combined cycle gas turbine

132 Performance assessment was carried out for both engine configurations at ISO conditions using natural gas. These engines
133 were simulated after the GE 9E Frame engine; hence validation of the engine models was achieved by comparing outputs
134 to publicly available information. Considering local variations in ambient temperatures, off-design analyses were
135 performed with comparative engine assessment using natural gas, conventional diesel and Jatropha biodiesel fuels. The
136 input data and model assumptions for engine simulation are listed in Table 1 for OCGT and Table 2 for CCGT
137 respectively. A generic Jatropha biodiesel production system —cultivation, harvesting, oil extraction, conversion via
138 transesterification and associated transportation processes— is described elsewhere in Onabanjo *et al.* [43], while fuel
139 chemical composition, as defined in Aspen Plus®, is listed in Table 3.

Table 1: Engine input data and model assumptions for the OCGT/Topping cycle

Table 2: Engine input data and model assumptions for the Bottoming cycle

Table 3: Parameters/Properties for the different fuels

2.2. COST ESTIMATION

The operating cost includes fuel cost, and associated costs of operating the different utilities such as pumps and drivers. The maintenance costs cover fixed and variable maintenance costs. The fixed maintenance cost was calculated using the fixed maintenance cost factor in Table 4 multiplied by the total power output of the engine. The variable maintenance cost takes into account the influences of fuel properties and ambient conditions on hot gas path components. This is based on the assumption that thermal stress and creep are the dominant failure modes in the baseload operation of these engines. Since the first stages of the turbine blades encounter extreme hot conditions and are critical components in maintenance schedules, the gas path for the first stages of the turbine was sized appropriately by calculating the blade height and distance from mid-shaft to mid-blade. The blade temperature and time-to-failure were then estimated using the Larson-Miller Parameter (LMP) method [44-46]. These calculations involve an initial estimation of the centrifugal force acting on the blade at the mid-root section, a function of the design point rotational speed of the turbine. The estimations offer an introductory value for the variable maintenance costs for the three fuel scenarios. A step-by-step description of the method for the variable maintenance cost estimation is outlined in Onabanjo *et al.* [47]. Fuel costs were calculated based on the fuel consumption rate of the engines. The local market price of both biodiesel and conventional diesel fuels were assumed to be \$5.5/gallon based on the bulk pump price of diesel fuels in Nigeria and with the consideration that fuel prices of Jatropha biodiesel would have to be competitive with diesel for successful adoption. The local price of natural gas was \$2.8/MMBTU [48-51]. These fuel costs account for the cost associated with the production and transportation of the fuel to the power plants. Emission costs of the engines were calculated based on carbon balance and using the carbon emissions of the flue gas, but this assumes that the fuel is completely combusted. A zero carbon tax rate was applied to the base case study; however, a scenario analysis considered a range of carbon tax of \$0-100/tC. All costs including fixed maintenance costs and capital costs, as inputted in the economic model, are outlined in Table 4.

Table 4: Input in the Economic Model

2.3. ECONOMIC ANALYSIS

The economic analyses for the Jatropha biodiesel-fired plants were conducted in comparison with the natural gas- and conventional diesel-fired plants using economic parameters [50, 52-53] such as: i) Net Present Value, ii) Levelized Cost of Electricity and iii) Simple Payback Period.

Net Present Value (NPV) defines the economic viability of a project as it examines the revenues and costs over a discounted time [50]. NPV was calculated using equations 1, assuming an annual real discount rate equal to the project's

171 weighted average cost of capital (WACC) as provided by [49]. A constant dollar cash flow was used at the end of the
 172 period, i.e. 2012, with an annual escalation rate of 11% apart from the base year.

$$173 \quad NPV = - \text{Initial Investment} + \sum_{t=1}^T \frac{\text{Net Cash Flow}_t}{(1+d)^t}$$

174 eqn. (1)

175 where d is the annual real discount rate in %, T is the plant's project life in years or analysis period and t is the net cash
 176 flow each period. The depreciation rate assumes the salvage value at the end of the project is 0. There are no further
 177 investments, so the annual capital cost after the first year is 0.

178 **Levelized Cost of Electricity (LCOE)** accounts for the total life cycle cost (TLCC) when discounted to the base year
 179 [50-51]. It considers the estimated cost of installing and operating projects over a period of time, and is used to compare
 180 projects under different operating conditions. It primarily describes the TLCC per every unit of energy generated over the
 181 project life. In this study, LCOE was calculated using equations 2-4 and is expressed in \$/MWh.

$$182 \quad LCOE = \left(\frac{TLCC}{Q} \right) URCF \quad \text{eqn. (2)}$$

$$183 \quad TLCC = \sum_{t=1}^T \frac{C_t}{(1+d)^t} \quad \text{eqn. (3)}$$

$$184 \quad URCF = \frac{d(1+d)^T}{(1+d)^T - 1}$$

185 eqn. (4)

186 where Q – annual energy output (MWh), $URCF$ – uniform capital recovery factor

187 The outputs for the OCGT and CCGT were compared with those of SGE in Nigeria. The latter analysis was conducted
 188 using the primary data in Table 4, as obtained from a local analytical laboratory and household.

189 **Simple Payback Period (SPB)** is a quick assessment measure that defines the number of years required to recover the
 190 cost of investment in the project [50]. This was calculated using equation 5 and is expressed in years.

$$191 \quad SPB = \Delta I_n \leq \Delta S_n \quad \text{eqn. (5)}$$

192 where ΔI_n – non-discounted capital costs, ΔS_n – non-discounted summation of annual cash flows

193 Sensitivity analysis was then carried out to determine the individual influence of key parameters, such as capacity factor,
 194 company tax rate, depreciation rate, escalation rate, capital cost, maintenance factor (fixed and variable) and fuel price,
 195 on the economic performance of the Jatropha biodiesel-fired plants.

196

197 3. Results and Discussion

198 3.1. Engine Validation

199 Table 5 presents the outcomes of the simulated engines (OCGT and CCGT) when operated on natural gas with net heating
200 value (HV_{net}) of 49.07 MJ/kg at ISO conditions. The results show a relatively low percentage error for the different
201 parameters (i.e. power output, heat rate, thermal efficiency, exhaust mass flow and exhaust gas temperature) when
202 compared to the MS9001 E engine [54]. The percentage error ranged between 0.24% and 1.79% for the OCGT and
203 between 2.27% and 4.01% for the CCGT. The slight differences in heat rates and net plant efficiencies for both engines
204 are indications of a variation in the HV_{net} of natural gas, a value which was not reported in [54].

205 **Table 5: Engine Validation of the Natural Gas OCGT and CCGT engines at ISO Conditions**

206 3.2. Engine Performance Analysis

207 Table 6 shows the results of the engine performance analysis based on the use of various gas turbine fuels (i.e. natural
208 gas, diesel and Jatropha biodiesel) in OCGT and CCGT engines under site conditions. Considering the open cycle
209 configuration, the results show a decrease of 1.79% in net plant output (NPO) and 0.92% in net plant efficiency (NPE) of
210 the Jatropha biodiesel Fired OCGT Plant (-FOP) when compared to the natural gas case. These values correspond to an
211 increase in the heat rate of the engine of 0.96%. A similar comparison with diesel-FOP shows that the engine performance
212 of the Jatropha biodiesel-FOP is slightly higher by ~1%. Here an increase in NPO and NPE of 0.94% and a decrease of
213 0.98% in heat rate are observed for the Jatropha biodiesel-FOP in comparison with the diesel-FOP. This positions the
214 natural gas-FOP as the highest performing power plant and diesel-FOP as having the lowest performance. For the
215 combined cycle configuration, the Jatropha biodiesel-Fired CCGT Plant (-FCP) had a minimal loss of 1.43% and 0.60%
216 in NPO and NPE respectively. The reduction in NPE was complemented by an increase in heat rate of 0.59% when
217 compared to the natural gas case. Similarly, the diesel-FCP had a reduced NPO and NPE, but to a lesser degree than the
218 OCGT counterpart, with values of 2.02% and 1.19% respectively in comparison to the natural gas case. This positions
219 the Jatropha biodiesel-FCP as having a slightly better performance than the diesel-FCP but at a lesser output than the
220 natural gas case. Here, the NPO and NPE of the Jatropha biodiesel-FCP increased by 0.60%, and the heat rate reduced by
221 0.66%.

222 **Table 6: Technical Analysis of the OCGT and CCGT engines (different fuels) under Site Conditions**

223 The slight differences observed in the NPO, NPE and heat rate for the different fuel scenarios are relatively small
224 compared to the engine's fuel flow rate. As mentioned in section 2.1., the gas generators were modelled with a maximum
225 firing temperature and this setting ensures that fuel flow rates are suitably adjusted such that firing temperatures are
226 reached but not exceeded. It also ensures that a relatively constant combustor outlet temperature (COT) is reached, which
227 in turn preserves turbines' metal blades and the life of engine components. Hence, the maximum engine firing temperature

228 has necessitated the adjustment of the engine's fuel flow rate, such that a considerable increase of nearly 14% and 33%
229 was observed in the diesel- and Jatropha biodiesel-fired plants respectively, in the place of natural gas. These significant
230 fuel adjustments are as a result of the reduced heating values of the fuels. In this study, the diesel and Jatropha biodiesel
231 fuels have HV_{net} of 42.58 MJ/kg and 36.58 MJ/kg respectively, corresponding to a reduced energy content of 13% and
232 25% when compared to the HV_{net} of natural gas.

233 Another added influence is the chemical composition, primarily the carbon, hydrogen and oxygen content of the fuels.
234 Meher-Homji *et al.* [55] reported that gas turbines operating on natural gas will produce a range between 2% and 3% of
235 power output more than engines using distillate oil. This is because of the relative higher specific equivalent power
236 obtained from natural gas, a function of the molar hydrogen-to-carbon (H/C) ratio of the fuel. In this study, the natural
237 gas is primarily composed of methane, and has a molar H/C that is about one-third of the mixture, while the molar H/C
238 of the diesel and biodiesel fuels is less than one-fifth. An analysis of the flue gas composition shows that the mass H/C
239 ratios are 0.61, 0.15 and 0.19 while mass hydrogen-to-oxygen H/O ratios are 0.144, 0.088 and 0.093 for natural gas, diesel
240 and Jatropha biodiesel respectively. These values are in the order of the specific equivalent power for the respective power
241 plants (OCGT and CCGT) and within the range of 2-3%. And, although there is a larger carbon content in diesel and
242 Jatropha biodiesel fuels, which can contribute to the further production of carbon dioxide (CO_2) in the flue gas and
243 increased gas mass flow and specific heat capacity of the combustion products, this is counterbalanced by the lower LHV
244 fuels. The loss of NPO and NPE for the diesel- and Jatropha biodiesel-FOP/FCP engines is therefore as a result of the
245 relatively large amount of fuel that is added to the system to compensate for the lower LHV fuels.

246 In summary, the engine performance analysis shows that the Jatropha biodiesel fired plants have a close performance
247 characteristic and slightly improved performance compared to conventional diesel-fired engines, hence Jatropha biodiesel
248 can be considered as an alternative. The results also show that Jatropha biodiesel can be substituted for natural gas in
249 industrial gas turbines and for distributed or embedded power generation in Nigeria, particularly for power stations in
250 remote locations with limited access to the existing natural gas distribution networks. The use of the fuel however comes
251 at a cost of increased fuel consumption with slight loss in power (~2%) and plant efficiency (~1%). Since fuel costs may
252 account for over two-thirds of the operator's annual operating cost, the above results show that the use of Jatropha
253 biodiesels in CCGTs is the best alternative. This is due to the additional power output derived from the bottoming cycle
254 at no added heat input, hence a reduced specific fuel cost with increased potential earnings for the power station.

255 The differences observed between the data for ISO and site conditions in the natural gas-FOP/FCP are mainly due to
256 ambient effects. Here, the increased ambient temperature reduces the density of the air flowing into the compressor. This
257 consequently reduces the compressor delivery pressure and air flow rates going through the engine, and causes an overall
258 reduction in specific power output and thermal efficiency of the engine. The thermal efficiency is worsened because more

259 fuel is consumed in order to maintain the engine's COT. Meher-Homji *et al.* [56] report an ideal reduction in power output
260 between 0.3% and 0.5% for every degree Fahrenheit rise in ambient temperature. Bacha *et al.* [57] report a 0.5% to 0.9%
261 drop in power output for every 1°C rise in temperature. Similar trends are reported in Alhazmy and Najjar, [58], Mohanty
262 and Palaso Jr. [59], and Kakaras *et al.* [60]. In this study, an increase in ambient temperature caused a 0.44% loss in NPO
263 and 0.28% loss in NPE for every 1°C rise in temperature.

264 This study has not examined the fuel effects on the durability of engine components. It is nonetheless worth mentioning
265 that the use of liquid fuels requires that the fuel pressure level is correctly set to ensure that the minimum fuel supply
266 pressure is reached and accounts for pressure in the combustor and losses in the fuel system [55]. Also, effective fuel
267 atomizers would be required for optimum fuel evaporation rates and to ensure a thorough mixing of the fuel and air. Silva
268 *et al.* [61] have demonstrated the importance of employing control strategy such as air bleeds and guide vanes in the event
269 of utilizing relatively LHV fuels to optimize the operational conditions of the engine and ensure safe operation. Meher-
270 Homji *et al.* [55] also showed how a power correction factor could be applied to engines operating on fuels with LHV
271 and containing inert gases and varying C/H ratio.

272 3.3. Economic Analysis

273 The results of the economic analysis for the Jatropha biodiesel-fired plant in comparison with the natural gas- and
274 conventional diesel-fired plants are presented in Table 7. The results show that the LCOE of the Jatropha biodiesel-FOP
275 and -FCP are \$0.252/kWh and \$0.203/kWh respectively. These values exceed the current and proposed wholesale
276 electricity generation price for gas power plants in Nigeria. The NERC outlines the wholesale electricity generation price
277 for 2012 new entrants' gas power plants as \$0.081/kWh and for 2016 new entrants' gas power plants as \$0.113/kWh.
278 Although the commission presents a wholesale generation contract price of \$0.232/kWh for biomass power plants, there
279 was no direct reference to biodiesel-fired plants. Based on the regulated electricity generation price of \$0.113/kWh, Table
280 7 shows that the NPV of the Jatropha biodiesel-FOP is in deficit (i.e. -\$1614 million), as opposed to the positive NPV of
281 \$3,295 million for the natural gas-FOP. The SPB for the Jatropha biodiesel-FOP exceeded the lifetime of the project as
282 compared to the SPB of ~5 years for the natural gas-FOP. The B/C ratio of the natural gas-FOP was 4.45 while the
283 Jatropha biodiesel-FOP had none. Comparing the CCGT alternatives, however, the results show that the LCOE for the
284 Jatropha biodiesel-FCP is 10% higher than the diesel-FCP, nearly 3 times higher than the natural gas-FCP and 79% higher
285 than the electricity generation price of \$0.113/kWh, but it is 14% less than the contract price for biomass power plants.
286 Here, the NPV of the Jatropha biodiesel-FCP is \$439 million, SPB is about 20 years and B/C is 0.06 at the electricity
287 generation price of \$0.113/kWh. These results imply that Jatropha biodiesel-fired plants would require financial support
288 to be as economically viable and competitive as the natural gas plants.

289 **Table 7: Economic Analysis of OCGT and CCGT at Site Conditions**

290 Analysis of the LCOE in different countries by Salvador [62] indicates a range of \$0.114-0.141/kWh for natural gas-FCPs
 291 in the United Kingdom at 80% capacity factor (CF) and \$0.061-0.069/kWh in the United States at 60-80% CF. The rest
 292 of the world were averaged at \$0.069/kWh at 68% CF according to the same report. These values varied from \$0.05-
 293 0.15/kWh at 10% discount rate based on another report [63]. Typically, the LCOE of OCGT engines are usually higher
 294 than those of the CCGTs, because OCGTs are often used as peaking plants. For baseload operation, Salvatore [62] showed
 295 an LCOE of \$0.08/kWh at 10% discount rate and a CF of 85-90% for gas-fired OCGT engines, and ~\$0.4/kWh at 85%
 296 CF and 10% discount rate for diesel-fired OCGT engines in South Africa. Silinga and Gauché [64] also showed that the
 297 LCOE for diesel-fired OCGT in South Africa was as high as \$0.63/kWh, while the LCOE of gas-fired OCGT engines
 298 was reported to be in excess of \$0.10/kWh and up to \$0.26/kWh under different economic conditions [65-66].

299 3.3.1. Average Cost of Self-Generated Electricity in Nigeria

300 The average cost of SGE in Nigeria was estimated using the data of a small-medium enterprise (SME) with 20 staffing
 301 capacity and a typical household in Delta State, Nigeria. The SME operates two diesel engines (100 kVa and 80 kVa) for
 302 10 hours daily while the household operates a 22 kVa diesel engine for 6 hours daily balanced by the grid power supply.
 303 The rest of the day was considered as in a blackout condition, therefore additional energy costs or grid connections were
 304 not included in the analysis; however, the analysis considers incurring the costs of the diesel-powered engines, and the
 305 operating and maintenance costs for a 20-year period, but excludes the costs of emissions at the industrial power plants
 306 —Table 8.

307 **Table 8: The Average Cost of Self-Generated Electricity in Nigeria**

308 The LCOE for SGE was \$0.19/kWh for the SME and \$0.46/kWh for the household based on the use of diesel generators
 309 for 10-hours' and 6-hours' duration respectively. Considering a continuous engine use operation, the analysis shows that
 310 the LCOE for SGE can increase up to 0.45/kWh and \$0.70/kWh for the SME and household respectively. These values
 311 are considerably higher for the household than the SME, due to the small capacity and low efficiency of privately-owned,
 312 small diesel engines. These values are similar to the outcomes of the survey in Lagos State [8]. Ogunbiyi [8] showed that
 313 the average cost of SGE in 87% (1,723 homes) of Magodo I residents in Lagos State is ₦52.04/kWh (~\$0.32/kWh at
 314 2012 Naira-\$ exchange rate of 161). This value accounts for the cost of purchasing the diesel/petrol generators and the
 315 daily fuel consumption of the engines for a 7-hour period, but excludes the cost of maintaining the engines. The electricity
 316 consumption in Nigeria is averaged at 149kWh/capita, a value that is significantly low compared to countries such as
 317 South Africa (4315kWh/capita) and Brazil (2438kWh/capita) [67]. Electricity supply in Nigeria has not exceeded 5 GW,
 318 while electricity demand was estimated at ~13 GW in 2012 and projected to increase to 41 GW in 2015 and 88 GW in
 319 2020. About 2.6 GW of decentralized diesel generators are said to be in operation in the country and over 85% of local
 320 companies and industries own one or more generators [68]. This large and increasing energy demand in poor power
 321 situations therefore opens a potential market opportunity for embedded power generation.

322 Considering the high cost of SGE in Nigeria, the results in Table 7 show that the LCOE for Jatropha biodiesel-fired plants
323 could be three times more than the natural gas power plants; however, the costs of SGE in Nigeria are indications of
324 prospective market opportunities for Jatropha biodiesel-fired plants. The household benefits from a reduced energy cost
325 of 64% and 71% from the JT-FOP and -FCP engines respectively in comparison to a continuous use operation of diesel
326 generating sets; the SME with a similar electricity consumption pattern will benefit from a 44% and 55% reduced
327 electricity cost respectively. This is a substantial reduction in operating costs, since businesses can consume more than
328 10 GWh of electricity per annum. Even for the SME, where the LCOE for SGE during active business operating hours
329 appears smaller than the base-case scenarios of the Jatropha biodiesel-fired plants, the cost of shutting down business
330 operations and industrial equipment as well as loss of potential gain or opportunity costs can exceed any reasonable
331 benefit. Based on these considerations, the study further investigated the possibility of integrating Jatropha biodiesel in
332 power plants using different forms of financial instruments that can ensure Jatropha biodiesel-fired plants are as
333 competitive as natural gas plants. These employ a means to reduce the TLCC and increase the revenue of the power plant,
334 or business model that can accommodate a multiple use of fuels.

335 **3.4. Economic Scenarios for Integrating Jatropha Biodiesel into the Energy Mix**

336 The 'Renewable Energy Programme' (REP) is the main public institution guiding the activities of renewable energy
337 development in Nigeria. This initiative was launched by the Federal Ministry of Environment to transit the country to a
338 clean, reliable and sustainable energy supply and to ensure that targets on emission reductions as a party to the United
339 Nations Framework on Climate Change (UNFCCC) and sustainable energy development as part of the Millennium (*now*
340 *Sustainable*) Development Goals are met. To support these activities, the Energy Commission of Nigeria (ECN) and the
341 United Nations Development Programme (UNDP) developed a Renewable Energy Master Plan, which sets out a road
342 map for integrating renewable energy sources in existing electricity generation and distribution systems. This is supported
343 by the National Renewable Energy and Energy Efficiency Policy (NREEEP), a policy framework designed to power
344 generation capacities and share of renewable energy sources in Nigeria. Based on the REP initiative, the Nigerian Biofuel
345 Programme was established, which is supported by the Nigerian Biofuel Policy to reduce the country's dependence on
346 fossil fuels and increase the energy and fuel mix of Nigeria through local production of biogas, biodiesel and bioethanol.
347 The initiative has involved a number of stakeholders: local distilleries, refineries and organizations such as the Nigerian
348 National Petroleum Corporation (NNPC), Department of Petroleum Resources (DPR), National Petroleum Investment
349 Management Services (NAPIMS), Petroleum Products Marketing Company (PPMC) and Nigerian Gas Company (NGC),
350 each playing their role. NAPIMS is expected to invest in biofuel ventures, DPR acts as a regulatory body, while NNPC
351 and PPMC receive the output from the distilleries and refineries and blend them with refined petroleum products for
352 distribution to the end consumers. NGC is mainly involved in the biogas project and acts as a receiver and distributor of
353 any required gas supply in these initiatives. Some of the bio-ethanol and biodiesel projects include the 6-automotive

354 biofuel project using sugar cane and cassava feedstocks, two ethanol refineries using sorghum and 12 other bio-ethanol
355 projects [69]. Jatropha was recently approved to be grown nationwide, and possibly intercropped with maize and cassava
356 plants. Thus, the following sub-section examines the economic scenarios by which Jatropha biodiesel can be integrated
357 into existing power plants or used in dedicated power plants for embedded power generation.

358 Kost *et al.* [70] made note of the important role conventional diesel power plants play in electricity generation in Middle
359 East countries, accounting for nearly 88% of the energy mix in Saudi Arabia. This was only achievable with fuel
360 subsidization, which is a highly contentious issue in Nigeria. Despite the cost of fuel subsidy and related incentives, there
361 are potential economic benefits. In developed economies, renewable fuels have appreciably penetrated the energy mix of
362 many countries because of government support and platforms such as production-based renewable incentives, tax credits,
363 and subsidy programmes. As a result, and in addition to advances in technology, the cost of renewable energy has been
364 declining and penetration of renewable energy production has increased substantially. For instance, the UK operated a
365 minimum feed-in tariff system that pays an energy generator a minimum guaranteed amount for any renewable energy
366 generated (used or sold to the grid) over a period of years. In the US, the energy generator receives a tax credit that has
367 lowered the electricity cost of production from renewable energy sources. This has brought about significant economic
368 benefits and growth, and can be adopted by developing economies to ramp up renewable energy projects, particularly for
369 biodiesel-fired plants. This study considers four support scenarios: a) the provision of production-based incentive, b)
370 mandatory renewable energy fuel integration with and without renewable tax relief for the hours a plant operates on
371 renewable fuels, c) carbon tax and d) fuel subsidy.

372 **3.4.1. Production-Based Incentive (PBI)**

373 At the NERC regulated price of \$0.113/kWh, Figure 3 illustrates that a PBI support of up to \$0.082/kWh and \$0.052/kWh
374 would be required to support the Jatropha biodiesel-FOP and -FCP plants respectively to ensure these plants are as
375 competitive as their natural gas counterparts. A PBI support throughout the life of the project ensures that the Jatropha
376 biodiesel-FOP benefits from an SPB of six years, B/C of 0.42, and NPV of \$3 billion. The Jatropha biodiesel-FCP on the
377 other hand benefits from an SPB of 11 years, B/C of 0.32 and NPV of \$2.6 billion. For a limited period of time, a PBI
378 support of \$0.082/kWh for seven years and \$0.052/kWh for nine years can ensure the respective Jatropha biodiesel-FOP
379 and -FCP plants recover their TLCCs at least. If Jatropha biodiesel-fired plants are considered as biomass power plants,
380 a PBI support of \$0.01/kWh can ensure that the TLCC of the Jatropha biodiesel-FOP is recovered, but the Jatropha
381 biodiesel-FCP requires no support as its LCOE is below \$0.232/kWh. In a worst case scenario, where the Jatropha
382 biodiesel-fired plants are required to be as competitive as the gas-fired plants, a PBI support of \$0.102/kWh and
383 \$0.073/kWh would be required to support the Jatropha biodiesel-FOP and -FCP plants respectively. Fig. 3: The LCOE of
384 the Jatropha biodiesel-fired plants with production-based incentive (PBI) support

385 Salvador [62] showed that feed-in tariffs (FITs) have driven generation costs down and improved the penetration of
386 renewable energy technologies —64% for wind energy technologies and 87% for photovoltaic cells. A report by
387 Rickerson *et al.* [71] showed that FITs are well established in the electricity sector in developed countries but only a few
388 developing countries have successfully integrated this. Some of the benefits highlighted include investment security,
389 reduced LCOE, increased energy access and diffusion of renewable energy technologies, particularly off-grid solutions,
390 reduced grid instability, stabilized electricity prices, improved electricity diversity and economic development in the form
391 of job creation [72]. This, however, can only be achieved with appropriate policy design supported by detailed fuel
392 integration studies.

393 To increase the share of renewable energy sources in the country's energy mix and to improve power generation capacities
394 in Nigeria, the ECN along with the UNDP have developed an NREEEP. This legislative framework will support the
395 Renewable Energy Master Plan, a road map aimed at integrating renewable energy sources in existing electricity
396 generation and distribution systems under short-, mid- and long-term goals. More so, the NERC, which is an independent
397 regulatory body that standardizes the Nigerian electricity supply, has set a 10% renewable energy integration mix to
398 encourage embedded generation and alleviate fossil fuel dependence. Therefore, the ongoing efforts to grow energy
399 dedicated crops, such as *Jatropha curcas*, and subsequent production and use of the derived biodiesels in power
400 generation, is expected to contribute to the 10% of the electricity required to be generated and sourced from renewable
401 energy sources in Nigeria by 2025 [73]. In this instance, a limited period PBI support can be of benefit because it can
402 ensure that a favourable environment is established for biodiesel fuel integration without resulting in an unnecessary
403 economic burden for the country. This can reduce TLCC and ensure the adoption of biodiesel fuels in power plants.

404 **3.4.2. Mandatory Renewable Energy Fuel Integration**

405 Assuming a mandatory fuel integration process for new entrant power plants with renewable tax relief for the hours a
406 plant operates on renewable fuels, Figure 4 shows that a minimum PBI support of 0.8 cents/kWh, 1.6 cents/kWh, 2.4
407 cents/kWh, 3.2 cents/kWh will be required for a 10%, 20%, 30%, and 40% partial fuel substitution (PFS) respectively
408 with *Jatropha* biodiesel in the natural gas-FCP to ensure a comparative economic performance as the base-case scenario.
409 Otherwise the LCOE of the plant can increase to \$0.090/kWh (10% PFS), \$0.103/kWh (20% PFS), \$0.115/kWh (30%
410 PFS) and \$0.128/kWh (40% PFS), values that are beyond the current electricity contract price of \$0.077/kWh for gas
411 power plants. For partial substitution in the natural gas-FOP, the plants will require a higher minimum PBI support of 1.3
412 cents/kWh, 2.5 cents/kWh, 3.8 cents/kWh, 5.0 cents/kWh for PFS of 10%, 20%, 30%, and 40% respectively for a
413 comparative economic performance. In the absence of such support, the LCOE of the plant can be up to \$0.078/kWh,
414 \$0.098/kWh, \$0.117/kWh and \$0.136/kWh respectively and the plant owners cannot recover the cost of investment. For
415 the *Jatropha* biodiesel-fired plants to be as competitive as the gas-fired plants based on the 2016 NERC regulated price

416 of \$0.113/kWh, partial Jatropha biodiesel fuel substitution must not exceed 33% for the Jatropha biodiesel-FOP and 40%
 417 for the Jatropha biodiesel-FCP. In both plant scenarios, partial substitution refers to a fraction of the plant operating hours
 418 on Jatropha biodiesel fuel, particularly aimed at periods when fossil fuel is unavailable.

419 Fig. 4: The LCOE of the natural gas-fired plants with mandatory fuel substitution

420 3.4.3. Carbon Tax

421 The use of renewable fuels and technologies has become one of the major precautionary measures for greenhouse gas
 422 (GHG) emission reduction. Worldwide, market based mechanisms such as carbon tax and emissions cap-and-trade
 423 systems are implemented to achieve national and regional emission reduction targets and to favour the investment,
 424 development and establishment of low carbon technologies, especially in power generation. To reduce social costs and to
 425 minimize negative burdens and influences on economic growth, employment and security, these mechanisms are usually
 426 supported or incentivized by other tax relief systems. In the electricity sector, carbon tax is established per ton of emissions
 427 and is increasingly applied across many countries [74-75], which in turn is based on fuel type and energy conversion
 428 technology. In Europe, carbon costs vary from €5-30/tCO₂ and are expected to increase beyond €50/tCO₂ [76]. Ellis *et al.*
 429 [77] showed that British Columbia introduced a carbon tax of \$10/tCO₂ eq. that progressively increased by an additional
 430 \$5/tCO₂ eq. every year from 2008 to 2012 for power plants operating on coal, diesel, gasoline, propane and fuel oil and
 431 this favoured the use of biofuels. Countries such as Chile, Japan, Norway, South Africa and Sweden have applied carbon
 432 tax (\$2-168/tCO₂eq.) to enhance the diffusion of renewable energy technologies [78].

433 Fig. 5: The LCOE of the natural gas-fired plants with carbon tax levy

434 In this study, the natural gas-, diesel- and Jatropha biodiesel-FOP emitted 169 tC/MWh, 230 tC/MWh and 235 tC/MWh,
 435 and the -FCP counterparts emitted 109 tC/MWh, 149 tC/MWh and 151 tC/MWh respectively. While the carbon emissions
 436 from the fossil-fired plants are considered as anthropogenic pollutants, those resulting from the combustion of Jatropha
 437 biodiesel fuels are from biogenic sources, hence can be considered as neutral. Assuming that the fossil-fired plant receives
 438 a carbon levy per ton of carbon emissions while the Jatropha biodiesel-fired plant receives none, Figure 5 shows that the
 439 LCOE for the NG-FOP can approach the NG-FCP at carbon cost of about \$100/tCO₂ (\$367/tC). Here, the LCOE of the
 440 NG-FOP and NG-FCP increases to \$0.114/kWh and \$0.115/kWh respectively, a corresponding 49% and 32% loss in a
 441 plant's economic performance. These can be accompanied by an increase in the SPB by one and two years, and decrease
 442 in B/C ratio to 1.58 and 1.09 for the NG-FOP and NG-FCP respectively. The NPV of these plants can also reduce to 2,672
 443 million (NG-FOP) and 3,622 million (NG-FCP), a corresponding 23% and 34% reduction from the baseline values at the
 444 electricity generation price of \$0.113/kWh.

445 Although the natural gas-fired power plants were less competitive, the imposed carbon cost was not sufficient to make
 446 the Jatropha biodiesel-fired plants economically competitive as the natural gas plants. This is because the percentage

447 contribution of individual costs (i.e. capital, fuel, maintenance and emission costs) for the power plants varies for the
448 different fuels. At carbon cost of \$100/tCO₂, the emission costs cover 38%, 23% and 19% of the total costs for the CCGT,
449 and 56%, 26% and 22% for the OCGT for natural gas, diesel and Jatropha biodiesel respectively. Fuel costs on the other
450 hand have a meagre share (i.e. 2-3%) of the total annual costs of the natural gas plants, but a significant share of the
451 liquid-fired plants, about 51%-65%. More so, there are growing environmental concerns on the production system of
452 *Jatropha curcas*, that could significantly influence the carbon credit system of Jatropha biodiesel-fired plants. Some
453 authors have reported a reduction in GHGs [79-80], while Ariza-Montobbio *et al.* [81] and Findlater and Kandlikar [82]
454 showed that the use of biodiesels could increase GHG emissions. This is because the production system of *Jatropha*
455 *curcas* and subsequent conversion of the oil to biodiesel requires the use of fossil fuels and nitrogen-based fertilizers that
456 could significantly increase the environmental burden of the fuel. It is also anticipated that their cultivation could
457 negatively impact on land and water use, as well as contribute to higher food prices and shortages in developing countries
458 [82]. The crop was originally recommended to be grown on degraded or wasteland with minimal agricultural inputs [83]
459 due to the crop's resilient abilities to adapt to poor soil and adverse climatic conditions. However, studies by Achten *et*
460 *al.* [84], Ariza-Montobbio *et al.* [81] and Axelsson *et al.* [85] have shown that there is a significant cost on seed and oil
461 yield. In this context, Jatropha biodiesel is considered to be a low carbon project and not a neutral carbon system. For
462 energy and environmental balance, a seed yield of at least 2 tonnes per ha per year is recommended [79]. This can further
463 be improved with the use of superior genetic seed strains, agricultural practices and soil conditions [79; 84]. Therefore, a
464 complete environmental life cycle assessment will be required to support any carbon trading or credit system. High quality
465 fuel production and conversion will be required to avoid any negative influence on plant performance. Fuel price will
466 need to be competitive and renewable incentivized systems will need to be justified.

467 Based on the above considerations, an analysis of an incentive or carbon trading system, where the Jatropha biodiesel-
468 fired plants receive equivalent credits of carbon costs from natural gas-fired plants, shows that the LCOE of the Jatropha
469 biodiesel-fired plants can reduce significantly to \$0.185/kWh (NG-FOP) and \$0.159/kWh (NG-FCP) at a high carbon
470 cost of \$100/tCO₂, a 36% and 27% reduction in LCOE. This ensures that the Jatropha biodiesel -FCP has a positive NPV
471 at the end of the project with an SPB of 12 years and minimal B/C ratio of at least 0.35. In all the defined carbon tax
472 scenarios, CCGT as more energy efficient engines were best suited and could be used competitively for utilizing Jatropha
473 biodiesel fuel for power generation. For the diesel-fired plants, the LCOE of the plants exceed those of the Jatropha
474 biodiesel-fired plants at a carbon cost above \$40/tCO₂ (\$147/tC).

475 3.4.4. Fuel Subsidy

476 Typically, fuel cost is a major fraction of operational cost, and could be as high as 83%, but this depends significantly on
477 fuel consumption rate or plant's net efficiency and fuel market price. Figure 6 shows that the LCOE of the JT-FOP has a

478 similar economic performance to the natural gas-FOP under a fuel market price of \$0.5/gallon or less. This ensures that
479 the plant is economically viable at the wholesale electricity selling price of \$0.077/kWh. Above this value, the current
480 electricity selling price for gas power plants can hinder the economic viability of Jatropha biodiesel-fired plants. A fuel
481 price of \$1.8/gallon also ensures that the LCOE of the JT-FOP is the same as the JT-FCP, more so, it is equal to the
482 wholesale electricity selling price of \$0.113/kWh. Beyond the fuel price of \$1.8/gallon, the JT-FOP and -FCP cannot be
483 as competitive as the natural gas plants; hence, a different wholesale electricity selling price would be required, perhaps
484 at the wholesale electricity selling price for biomass power plants. At the electricity selling price of \$0.232/kWh, the fuel
485 price must not exceed \$5/gallon for the JT-FOP and \$8/gallon for the JT-FCP. Fuel subsidy as small as \$0.2/gallon and
486 as much as \$5/gallon therefore can be issued nationally for the integration of Jatropha biodiesel fuel in power plants. The
487 magnitude of benefits, however, depends on the cost of production of the fuel and the market price of alternate fuels.

488 Fig. 6: The LCOE of the Jatropha biodiesel-fired plants at varying fuel prices

489 4. Sensitivity Analysis

490 The economic analyses presented in this study are based on point estimates, which individually or collectively can affect
491 the economic measures if different from the values presented in Table 4c. To determine the sensitivity of the different
492 parameters (i.e. capital costs, WACC, depreciation rate, inflation rate, company tax rate, discount rate, CF, auxiliary
493 components, fixed and variable maintenance costs) on the economic performance of the Jatropha biodiesel-fired plants,
494 each of the parameters was individually varied by 20% while all others were kept constant. The results are presented in
495 Figure 7 for JT-FOP and -FCP respectively.

496 Fig. 7: Sensitivity Analysis on LCOE of the Jatropha biodiesel-fired OCGT and CCGT

497 For both OCGT and CCGT engines, sensitivity values were similar, hence OCGT only is discussed. The results observed
498 in Figure 7 show that capital cost, CF, company tax rate, discount rate and Pre-Tax Real WACC have a range of
499 sensitivities between 4% and 18% in increasing order, while energy requirements for auxiliary components, inflation rate,
500 depreciation rate and maintenance costs have minimal influences, i.e. values less than 1% for a $\pm 20\%$ change in the base
501 value. For instance, a Pre-Tax Real WACC of 11% has been used throughout the analysis following the estimate of the
502 NERC [86]; however, this is an average value and varies from period to period. As such, the sensitivity analysis showed
503 that the LCOE decreased by 16.3% for a 20% decrease and increased by 18% for a 20% increase in Pre-Tax Real WACC
504 base values. Since Pre-Tax Real WACC is the actual costs incurred for the power plant via equity and debt, and prior to
505 tax reduction, the results imply that there is a significant risk and reduced economic value of the power plant with the
506 increase in Pre-Tax Real WACC value but a fair return rate on investment with the increased Pre-Tax Real WACC value.
507 A 20% reduction in discount rate brought about a decrease in LCOE by 14.0%; this is because there is a corresponding

508 increase in the present value of the net cash flow of the power plant. A reverse trend is observed with a 20% increase in
509 the discount rate. Here the LCOE increased by 14.7% which increases the risk in the future cash flow of the power plant.
510 The CF is the ratio of actual to potential output for a given period time. A value of 80% was allocated on the basis of
511 baseload operation but this can change due to factors such as pipeline vandalizing, fuel unavailability, poor maintenance
512 and other operating issues, resulting in increased downtime. It therefore reflects the annual operating hours of the power
513 plant, and affects both fuel and maintenance costs. The sensitivity analysis shows that an increase in CF by 20% can bring
514 about a reduction of 5.6% in LCOE but increases this by 3.7% for a 20% increase in the base value. Capital costs are
515 reported in the range of \$800-1000/kWh for OCGT and \$1000-1250kWh for CCGT [87]. A value of \$978/kWh was
516 adopted for OCGT based on NERC's recommendation and \$1476/kWh was assumed for the CCGT. These values include
517 the costs for procurement, engineering and construction, planning and approval, technical services, land acquisition,
518 infrastructure, water and effluent treatment, connection to transmission network, fuel handling and storage, i.e., the costs
519 of procurement and installation, which vary and depend on site location, plant design and capabilities and other local
520 factors, such as cost escalation and inflation. The sensitivity analysis shows that capital cost, company tax rate and
521 inflation rate changed by 3.9%, 8.2% and 1.2% for a $\pm 20\%$ change in the base value. Depreciation cost allocates part of
522 the investment costs over the plant's useful life, hence had minimal influence; as such a $\pm 20\%$ change in a depreciation
523 rate only brought about 0.6% change. These results demonstrate that LCOE for these power plants can be reduced
524 significantly by aiming at the reduction of the TLCC, mainly by improving a plant's CF and reducing discount rate,
525 company tax rate, capital cost and Pre-Tax Real WACC.

526 This study determined the cost of SGE in comparison to the regulated wholesale electricity generation (contract) prices
527 in Nigeria. It has considered various economic scenarios through which Jatropha biodiesel can be used for power
528 generation in Nigeria using industrial gas turbines. The study has not considered the impact of feedstock security that
529 might result from poor infrastructures, theft or competitive demands for oil. Further assessment would be required to
530 examine the socio-economic impact of the Jatropha biodiesel-power generation in Nigeria.

5. CONCLUSION

The techno-economic performance of a Jatropha biodiesel-fired plant with open and combined cycle configurations was evaluated and compared to fossil-fired engines, using NPV, SPB and LCOE. Economic mechanisms of integrating Jatropha biodiesel were explored with the aim of operating the plant with a suitable alternative without compromising the plant's economic viability. The results show that Jatropha biodiesel can be substituted for natural gas in industrial gas turbines and for distributed or embedded power generation in Nigeria. The use of this fuel, however, comes at a cost of increased fuel consumption with slight loss in power (~2%) and plant efficiency (~1%). The exclusive use of Jatropha biodiesel in the OCGT and CCGT engines can bring about an LCOE of 0.279/kWh and \$0.203/kWh respectively. These values exceed plants' projected revenue (i.e. electricity generation price of 0.081/kWh and 0.113/kWh for existing and new entrant plants respectively). At the electricity generation price for biomass power plants, only the Jatropha biodiesel-FCP is economically feasible and as competitive as gas power plants. Therefore, to integrate Jatropha biodiesel into power plants, a form of financial support would be required to ensure as competitive a plant performance as natural gas-fired plants. This could take the form of i) a minimum PBI of \$0.082/kWh for seven years for the Jatropha biodiesel-FOP and \$0.052/kWh for nine years for the Jatropha biodiesel-FCP, ii) a maximum PFS of 33% (Jatropha biodiesel-FOP) and 40% (Jatropha biodiesel-FCP) without any form of financial support, or iii) a guaranteed Jatropha biodiesel fuel price of \$/0.18/gallon. Beyond this fuel price, a different wholesale electricity contract price would be required. These mechanisms can guarantee that the generator recovers the initial cost of capital and operating costs. A carbon tax levy can also be imposed on natural gas-fired plants, which nearly doubles the LCOE with a carbon tax of \$100/tCO₂. These carbon tax scenarios do not guarantee the economic viability of the Jatropha biodiesel-fired plant. A combination of all the above mechanisms could be exploited to improve the competitiveness of the Jatropha biodiesel-fired plants. In a worst case scenario, where there are no government incentives, there are opportunities for distributed and independent power generation using Jatropha biodiesel, since the average cost of electricity was as high as \$0.45/kWh for the SME and 0.70/kWh for the household. The CCGT, as a more energy efficient engine, was best suited and could be used competitively for utilizing Jatropha biodiesel fuel for power generation.

ACKNOWLEDGEMENT

Part of this work was conducted during my doctorate degree. I would like to acknowledge my project supervisor, Dr Giuseppina Di Lorenzo for research guidance and supervisory support, Prof. Pericles Pilidis for the opportunity to join the gas turbine research community at Cranfield University and Dr Eric Goodger for insightful comments and support.

562 REFERENCES

- 563 1. International Energy Agency (IEA) 2014. World Energy Outlook 2014. IEA Publications, Paris.
- 564 2. Sambo A.S. 2008. "Matching Electricity Supply with Demand in Nigeria", International Association of Energy
565 Economics (IAEE), 4:32–36.
- 566 3. Oyedepo, S.O. 2012. "Energy and sustainable development in Nigeria: the way forward", Energy, Sustainability
567 and Society, 2(15): 1-17.
- 568 4. NBS, 2011. Nigeria - Multiple Indicator Cluster Survey (MICS4)-2011 Nigeria, Fourth round. NGA-NBS-
569 MICS4-2011-v1.0
- 570 5. Nigerian Energy Regulatory Commission (NERC), 2013. NERC and Civil Societies Partner for Affordable and
571 Reliable Electricity. Available on [http://www.nercng.org/index.php/media-and-publicity/press-releases/179-](http://www.nercng.org/index.php/media-and-publicity/press-releases/179-nerc-and-civil-societies-partner-for-affordable-and-reliable-electricity)
572 [nerc-and-civil-societies-partner-for-affordable-and-reliable-electricity](http://www.nercng.org/index.php/media-and-publicity/press-releases/179-nerc-and-civil-societies-partner-for-affordable-and-reliable-electricity). Accessed on 23 December, 2015
- 573 6. Energy Commission of Nigeria (ECN). 2012. Draft National Energy Master Plan.
574 <http://www.energy.gov.ng/index.php?option=com_docman&task=doc_download&gid=102&Itemid=49> (last
575 accessed on 06/9/2014).
- 576 7. UN COMTRADE, 2015. United Nations Commodity Trade Statistics Database. Available on
577 <http://comtrade.un.org/db/mr/rfCommoditiesList.aspx?px=H3&cc=8502> Accessed on 23 December, 2015
- 578 8. Ogunbiyi, D. 2013. Lagos State Government Energy Initiatives Electricity Board (LSEB). Presented at Exco/PS
579 Retreat.
- 580 9. Demirbas, A. 2008. Biodiesel: A Realistic Fuel Alternative for Diesel Engines, Springer London, pp 111-119
- 581 10. Lee, H.V., Taufiq-Yap, Y.H., Hussein, M.Z. and Yunus, R., 2013. Transesterification of jatropha oil with
582 methanol over Mg–Zn mixed metal oxide catalysts. Energy, 49, pp.12-18.
- 583 11. Kalam, M.A. and Masjuki, H.H. 2002. Biodiesel from palmoil - an analysis of its properties and potential.
584 Biomass and Bioenergy 23(6): 471-479.
- 585 12. Sheng, M., Wu, G.-Y., Xu, G. and Wu, M.-X. 2004. Preparation of biodiesel from rapeseed oil. Journal of
586 Chemical Engineering of Chinese Universities 18(2): 231-236.
- 587 13. Andersen, O. and Weinbach, J.-E. 2010. Residual animal fat and fish for biodiesel production: Potentials in
588 Norway. Biomass and Bioenergy 34(8): 1183-1188.
- 589 14. Lu, H., Liu, Y., Zhou, H., Yang, Y., Chen, M. and Liang, B. 2009. Production of biodiesel from Jatropha curcas
590 L. oil. Computers and Chemical Engineering 33(5): 1091-1096.
- 591 15. Heaton, E.A., Dohleman, F.G. and Long, S.P., 2008. Meeting US biofuel goals with less land: the potential of
592 Miscanthus. Global Change Biology, 14(9), pp.2000-2014.

- 593 16. Gonzáles, N.F.C., 2016. International experiences with the cultivation of *Jatropha curcas* for biodiesel
594 production. *Energy*, 112, pp.1245-1258.
- 595 17. Ong, H.C., Masjuki, H.H., Mahlia, T.M.I., Silitonga, A.S., Chong, W.T. and Yusaf, T., 2014. Engine
596 performance and emissions using *Jatropha curcas*, *Ceiba pentandra* and *Calophyllum inophyllum* biodiesel in a
597 CI diesel engine. *Energy*, 69, pp.427-445.
- 598 18. Ogunwole, J.O. 2014. "Development of Commercially Viable Plantations of *Jatropha Curcas* L: Case for
599 Promotion of Its Agricultural Research", *Advances in Plants and Agriculture Research*, 1(3): 00017
- 600 19. Brittain, R. and Litaladio, N. 2010. *Jatropha*: a smallholder bioenergy crop: the potential for pro-poor
601 development (Vol. 8). Food and Agriculture Organization of the United Nations (FAO).
- 602 20. Gupta, K.K., Rehman, A. and Sarviya, R.M. 2010. Bio-fuels for the gas turbine: A review. *Renewable and*
603 *Sustainable Energy Reviews*, 14(9), 2946-2955.
- 604 21. Hashimoto, N., Ozawa, Y., Mori, N., Yuri, I. and Hisamatsu, T. 2008. Fundamental combustion characteristics
605 of palm methyl ester (PME) as alternative fuel for gas turbines. *Fuel* 87(15-16): 3373-3378.
- 606 22. Liu, A. and Weng, Y. 2009. Effects of Lower Heat Value Fuel on the Operations of Micro-Gas Turbine. *Energy*
607 *and Power Engineering* 1(1): 28-37
- 608 23. Xue, J., Grift, T.E. and Hansen, A.C. 2011. Effect of biodiesel on engine performances and emissions.
609 *Renewable and Sustainable Energy Reviews* 15(2): 1098-1116
- 610 24. Dwivedi, G., Jain, S. and Sharma, M.P. 2011. Impact analysis of biodiesel on engine performance - A review.
611 *Renewable and Sustainable Energy Reviews* 15: 4633-4641
- 612 25. Sallevelt, J.L.H.P., Gudde, J.E.P., Pozarlik, A.K. and Brem, G. 2014. The impact of spray quality on the
613 combustion of a viscous biofuel in a micro gas turbine. *Applied Energy* 132: 575-585
- 614 26. Bolszo, C., McDonell, V. and Samuelsen, S. 2007. Impact of Biodiesel on Fuel Preparation and Emissions for a
615 Liquid Fired Gas Turbine Engine. ASME Paper No. GT2007-27652, pp. 493-502
- 616 27. Rahm, S., Goldmeer, J., Moliere, M. and Eranki, A. DATE. Addressing gas turbine fuel flexibility,
617 GER4601(06/09). Available at [https://powergen.gepower.com/content/dam/gepower-](https://powergen.gepower.com/content/dam/gepower-pgdp/global/en_US/documents/technical/ger/ger-4601-addressing-gas-turbine-fuel-flexibility.pdf)
618 [pgdp/global/en_US/documents/technical/ger/ger-4601-addressing-gas-turbine-fuel-flexibility.pdf](https://powergen.gepower.com/content/dam/gepower-pgdp/global/en_US/documents/technical/ger/ger-4601-addressing-gas-turbine-fuel-flexibility.pdf). Last accessed
619 on 06/9/2016
- 620 28. Szalay, D., Fujiwara, H. and Palocz-Andresen, M. 2015. Using biodiesel fuel for gas turbine combustors. *Fuel*,
621 84(82), p.80.
- 622 29. Rehman, A., Phalke, D.R. and Pandey, R. 2011. Alternative fuel for gas turbine: Esterified *Jatropha* oil-diesel
623 blend. *Renewable Energy* 36(10): 2635-2640.

- 624 30. Badami, M., Nuccio, P. and Signoretto, A. 2013. Experimental and numerical analysis of a small-scale turbojet
625 engine. *Energy Conversion and Management* 76: 225-233.
- 626 31. Fan, Y., Hashimoto, N., Nishida, H. and Ozawa, Y. 2014. Spray characterization of an air-assist pressure-swirl
627 atomizer injecting high-viscosity *Jatropha* oils. *Fuel* 121: 271-283.
- 628 32. Hashimoto, N., Nishida, H. and Ozawa, Y. 2014. Fundamental combustion characteristics of *Jatropha* oil as
629 alternative fuel for gas turbines. *Fuel*, 126, 194-201.
- 630 33. Onabanjo, T. and Di Lorenzo, G., 2015, June. Energy Efficiency and Environmental Life Cycle Assessment of
631 *Jatropha* for Energy in Nigeria: A “Well-to-Wheel” Perspective. In ASME 2015 9th International Conference on
632 Energy Sustainability collocated with the ASME 2015 Power Conference, the ASME 2015 13th International
633 Conference on Fuel Cell Science, Engineering and Technology, and the ASME 2015 Nuclear Forum (pp.
634 V001T06A004-V001T06A004). American Society of Mechanical Engineers.
- 635 34. Van Eijck, J., Smeets, E. and Faaij, A. 2012. *Jatropha*: A Promising Crop for Africa’s Biofuel Production? In
636 *Bioenergy for Sustainable Development in Africa* (pp. 27-40). Springer Netherlands.
- 637 35. Openshaw, K. 2000. A review of *Jatropha curcas*: an oil plant of unfulfilled promise. *Biomass and Bioenergy*
638 19:1-15.
- 639 36. Sampattagul, S., Suttibut, C. and Kiatsiriroat, T. DATE. LCA/LCC of *Jatropha* Biodiesel Production in
640 Thailand. *International Journal of Renewable Energy* 4(1):33-42.
- 641 37. Wegstein, M. and Adhikari, N. 2010. Financial Analysis of *Jatropha* Plantations, *Journal of the Institute of*
642 *Engineering, Kathmandu* 8(1):1-5.
- 643 38. Parajuli, R. 2014. Economics of biodiesel production in the context of fulfilling 20% blending with petro-diesel
644 in Nepal. *International Journal of Sustainable Energy* 33(2):435-447.
- 645 39. Quintero, J.A., Felix, E.R., Rincón, L.E., Crisspín, M., Baca, J.F., Khwaja, Y. and Cardona, C.A. 2012. Social
646 and techno-economical analysis of biodiesel production in Peru. *Energy Policy*, 43, pp.427-435.
- 647 40. Felix, E., Cardona, C.A. and Quintero, J.A. 2010. Technical and economic viability of biofuel production chains.
648 *Bioenergy and Food Security: The BEFS Analysis for Tanzania*. Rome: Food and Agriculture Organization of
649 the United Nations.
- 650 41. Yusuf, N.N.A.N. and Kamarudin, S.K., 2013. Techno-economic analysis of biodiesel production from *Jatropha*
651 *curcas* via a supercritical methanol process. *Energy Conversion and Management*, 75, pp.710-717.
- 652 42. Tewfik, S.R., Hawash, S.I., Atteya, N.K., El Diwani, G.I. and Farag, I.H. 2012. Techno-economic appraisal of
653 biodiesel from *Jatropha curcas*: An Egyptian case study. *Journal of Agricultural Science and Technology*.
654 B,2(3B), p.287.

- 655 43. Onabanjo, T., 2015. "Techno-economic and environmental assessment of gas turbines utilizing biofuels," PhD
656 Thesis, Cranfield University, United Kingdom. Available at <http://dspace.lib.cranfield.ac.uk/handle/1826/9280>
- 657 44. Larson, F.R. and Miller, J. 1952. Transactions ASME, Vol. 74, pp. 765-771.
- 658 45. Maccapani, M., Khan, R.S.R., Burgmann, P.J., Di Lorenzo, G., Ogaji, S.O.T., Pilidis, P., Bennett, I., A TERA
659 based comparison of heavy duty engines and their artificial design variants for liquified natural gas service,
660 Journal of Engineering for Gas Turbines and Power, 136 (2), art. no. 022001
- 661 46. Isaiah, T.-G., Dabbashi, S., Bosak, D., Sampath, S., Di Lorenzo, G., Pilidis, P., Life Analysis of Industrial Gas
662 Turbines Used As a Back-Up to Renewable Energy Sources, Procedia CIRP, 38, pp. 239-244.
- 663 47. Onabanjo, T.O., Di Lorenzo, G. and Somorin, Y. 2015. Application of Bio-fAEG, a biofouling assessment
664 model in gas turbines and the effect of degraded fuels on engine performance simulations. In Proceedings of the
665 2015 ASME Power Conference, San Diego, USA, June 28-July 2, Technical Publication Number: PowerEnergy
666 2015-49657.
- 667 48. Nigerian National Petroleum Corporation (NNPC). 2014. Oil & Gas Price Statistics.
668 <http://www.nnpcgroup.com/>. Last accessed on 06/9/2016
- 669 49. Nigerian Electricity Regulatory Commission (NERC). 2012. Multi-year tariff order for the determination of the
670 cost of electricity generation for the period 1 June 2012 to 31 May 2017. NERC, Abuja.
- 671 50. Short, W., Packey, D.J. and Holt, T. 2005. A manual for the economic evaluation of energy efficiency and
672 renewable energy technologies. Honolulu, Hawaii. University Press of the Pacific.
- 673 51. Kreith, F. and Krumbieck, S. 2013. Principles of Sustainable Energy Systems. CRC Press, USA
- 674 52. General Electric (GE) Power System. 2016. Gas Turbine and Combined Cycle Products. Available from
675 <http://www.kushaindustry.com/pdf/brochure/113-27620.pdf> and last accessed on May 29, 2017.
- 676 53. Di Lorenzo, G., Pilidis, P., Witton, J., Probert, D., A Framework for the Evaluation of Investments in Clean
677 Power-Technologies, *Computer Aided Chemical Engineering*, 30, pp. 492-496
- 678 54. Di Lorenzo, G., Barbera, P., Ruggieri, G., Witton, J., Pilidis, P., Probert, D., Pre-combustion carbon-capture
679 technologies for power generation: An engineering-economic assessment, *International Journal of Energy*
680 *Research*, 37 (5), pp. 389-402
- 681 55. Meher-Homji, C., Zachary, J. and Bromley, A. F. 2010. "Gas Turbine Fuels-System Design Combustion and
682 Operability", Proceedings of the Thirty-Ninth Turbomachinery Symposium, Turbomachinery Laboratory Texas
683 A&M University, College Station, Texas, pp. 155-186
- 684 56. Meher-Homji, C.B., Chaker, M.A. and Motiwala, H.M. 2001. Gas turbine performance deterioration.
685 Proceedings of the 30th Turbomachinery Symposium, Texas, USA. pp. 139-175.

- 686 57. Bacha, M., Shaahid, S.M. and Al-Hadhrami, L. 2012. Impact of Fuels on Performance and Efficiency of Gas
687 Turbine Power Plants. *Energy Procedia* 14: 558 – 565
- 688 58. Alhazmy, M.M. and Najjar, Y.S.H. 2004. Augmentation of Gas Turbine, Performance Using Air Coolers.
689 *Applied Thermal Engineering* 24 (2-3): 415-429.
- 690 59. Mohanty, B. and Palaso Jr., G. 1995. Enhancing Gas Turbine Performance by Intake Air Cooling Using an
691 Absorption Chiller. *Heat Recovery Systems and CHP* 15(1): 41-50
- 692 60. Kakaras, E., Doukelis, A., Prelipceanu, A. and Karellas, S. 2005. Inlet Air Cooling Methods for Gas Turbine
693 Based Power Plant. *J. Eng. Gas Turbines Power* 128(2): 312-317
- 694 61. Silva, E.B., Bringhamti, C., Assato, M. and Lima, R.C. 2013. Gas Turbine Performance Analysis operating with
695 low heating value fuels. *Engenharia Térmica (Thermal Engineering)* 12(2): 8-15.
- 696 62. Salvatore, J., 2013. *World Energy Perspective: Cost of Energy Technologies*. Bloomberg New Energy Finance.
- 697 63. OECD/IEA AND NEA. 2015. *Projected Costs of Generating Electricity*. Retrieved from
698 <https://www.iea.org/Textbase/npsum/ElecCost2015SUM.pdf> (last accessed on 24/9/2016).
- 699 64. Silinga, C. and Gauché, P. 2014. Scenarios for a South African CSP peaking system in the short term. *Energy*
700 *Procedia*, 49, pp.1543-1552.
- 701 65. Wagner, L. and Foster, J. (2011). *Is There an Optimal Entry Time for Carbon Capture and Storage? A Case*
702 *Study for Australia's National Electricity Market*. The University of Queensland. Retrieved from
703 http://www.uq.edu.au/economics/eemg_/pdf/07.pdf
- 704 66. Foster, J., Wagner, L. and Bratanova, A. 2014. *LCOE models: A comparison of the theoretical frameworks and*
705 *key assumptions*. Brisbane, Australia: University of Queensland, Australia.
- 706 67. OECD/IEA. 2014. *World Energy Outlook 2014*. IEA Publications, Paris, France.
- 707 68. The Nigerian Energy Support Programme (NESP). 2014. *The Nigerian Energy Sector -an Overview with a*
708 *Special Emphasis on Renewable Energy, Energy Efficiency and Rural Electrification*, 1-168,
709 <<https://www.giz.de/en/downloads/giz2014-en-nigerian-energy-sector.pdf>> (last accessed on 24/2/2015).
- 710 69. Ohimain, E.I., 2010. Emerging bio-ethanol projects in Nigeria: Their opportunities and challenges. *Energy*
711 *Policy*, 38(11), pp.7161-7168.
- 712 70. Kost, C., Mayer, J.N., Thomsen, J., Hartmann, N., Senkpiel, C., Philipps, S., Nold, S., Lude, S., Saad, N. and
713 Schlegl, T. 2013. *Levelized Cost of Electricity Renewable Energy Technologies*. Fraunhofer Institute for Solar
714 *Energy Systems*, Freiburg, Germany.
- 715 71. Rickerson, W., Laurent, C., Jacobs, D., Dietrich, C. and Hanley, C. 2012. *Feed-in tariffs as a policy instrument*
716 *for promoting renewable energies and green economies in developing countries*. Technical Paper, United
717 *Nations Environment Programme*, Washington, DC. http://www.unep.org/pdf/UNEP_FIT_Report_2012F.pdf

- 718 72. Nganga, J. 2013. Powering Africa through feed-in tariffs: advancing renewable energy to meet the continent's
719 electricity needs.
- 720 73. Energy Commission of Nigeria (ECN). 2012. Draft National Energy Master Plan.
721 <http://www.energy.gov.ng/index.php?option=com_docman&task=doc_download&gid=102&Itemid=49> (last
722 accessed on 06/9/2014).
- 723 74. Ericsson, K. and Nilsson, L.J. 2004. International biofuel trade—a study of the Swedish import. *Biomass and*
724 *Bioenergy*, 26(3), pp.205-220.
- 725 75. Timilsina, G.R., Csordás, S. and Mevel, S. 2011. When does a carbon tax on fossil fuels stimulate biofuels?
726 *Ecological Economics*, 70(12), pp.2400-2415.
- 727 76. Kaufman, N. Obeiter, M. and Krause, E. 2016. “Putting a price on carbon: reducing emissions” Issue Brief.
728 Washington, DC: World Resources Institute. Available online at <http://wri.org/carbonpricing>.
- 729 77. Ellis, K., Cantore, N., Keane, J., Peskett, L., Brown, D. and te Velde, D. 2010. Growth in a carbon constrained
730 global economy. Overseas Development Institute, London, UK.
- 731 78. Kennedy, K., M. Obeiter, and Kaufman, N. 2015. “Putting a Price on Carbon: A Handbook for U.S.
732 Policymakers.” Working Paper. Washington, DC: World Resources Institute. Available online at
733 <http://wri.org/carbonpricing>.
- 734 79. Achten, W.M., Mathijs, E., Verchot, L., Singh, V.P., Aerts, R. and Muys, B., 2007. Jatropha biodiesel fueling
735 sustainability? *Biofuels, Bioproducts and Biorefining*, 1(4), pp.283-291.
- 736 80. Wang, Z., Calderon, M.M. and Lu, Y. 2011. Lifecycle assessment of the economic, environmental and energy
737 performance of *Jatropha curcas* L. biodiesel in China. *Biomass and Bioenergy*, 35(7), pp.2893-2902.
- 738 81. Ariza-Montobbio, P., Lele, S., Kallis, G. and Martinez-Alier, J., 2010. The political ecology of *Jatropha*
739 plantations for biodiesel in Tamil Nadu, India. *The Journal of Peasant Studies*, 37(4), pp.875-897.
- 740 82. Findlater, K.M. and Kandlikar, M. 2011. Land use and second-generation biofuel feedstocks: the unconsidered
741 impacts of *Jatropha* biodiesel in Rajasthan, India. *Energy Policy*, 39(6), pp.3404-3413.
- 742 83. Francis, G., Edinger, R. and Becker, K. 2005, February. A concept for simultaneous wasteland reclamation, fuel
743 production, and socio-economic development in degraded areas in India: need, potential and perspectives of
744 *Jatropha* plantations. In *Natural Resources Forum* (Vol. 29, No. 1, pp. 12-24).
- 745 84. Achten, W.M., Nielsen, L.R., Aerts, R., Lengkeek, A.G., Kjær, E.D., Trabucco, A., Hansen, J.K., Maes, W.H.,
746 Graudal, L., Akinnifesi, F.K. and Muys, B. 2010. Towards domestication of *Jatropha curcas*. *Biofuels*, 1(1),
747 pp.91-107.

- 748 85. Axelsson, L., Franzén, M., Ostwald, M., Berndes, G., Lakshmi, G. and Ravindranath, N.H. 2012. Jatropha
749 cultivation in southern India: assessing farmers' experiences. *Biofuels, Bioproducts and Biorefining*, 6(3),
750 pp.246-256.
- 751 86. Nigerian Electricity Regulatory Commission (NERC). 2012. Multi-year tariff order for the determination of the
752 cost of electricity generation for the period 1 June 2012 to 31 May 2017. NERC, Abuja.
- 753 87. International Energy Agency, Energy Technology System Analysis Programme (IEA ETSAP) 2010 -
754 Technology Brief E02 — Gas-Fired Power [http://www.iea-etsap.org/web/e-techds/pdf/e02-gas_fired_power-gs-](http://www.iea-etsap.org/web/e-techds/pdf/e02-gas_fired_power-gs-ad-gct.pdf)
755 [ad-gct.pdf](http://www.iea-etsap.org/web/e-techds/pdf/e02-gas_fired_power-gs-ad-gct.pdf). Last accessed on 16/9/2015.
- 756

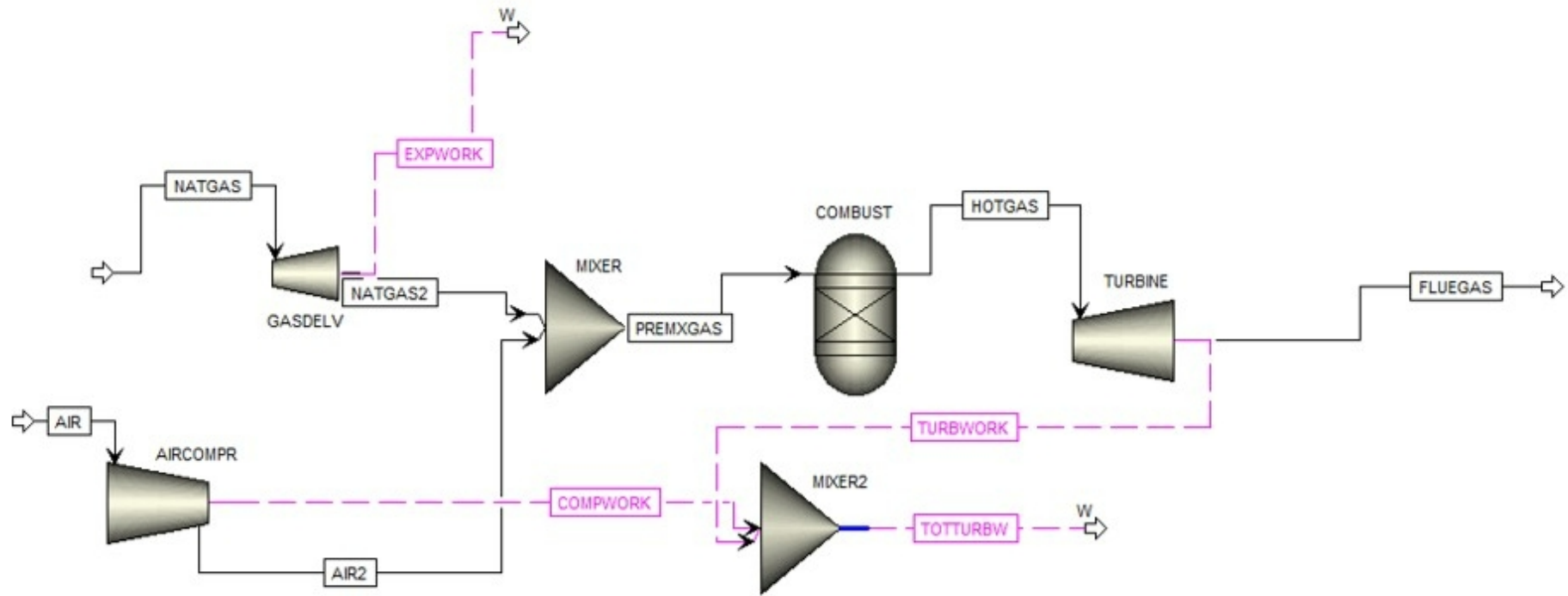

Figure 1: Simplified flow diagram of the open cycle gas turbine

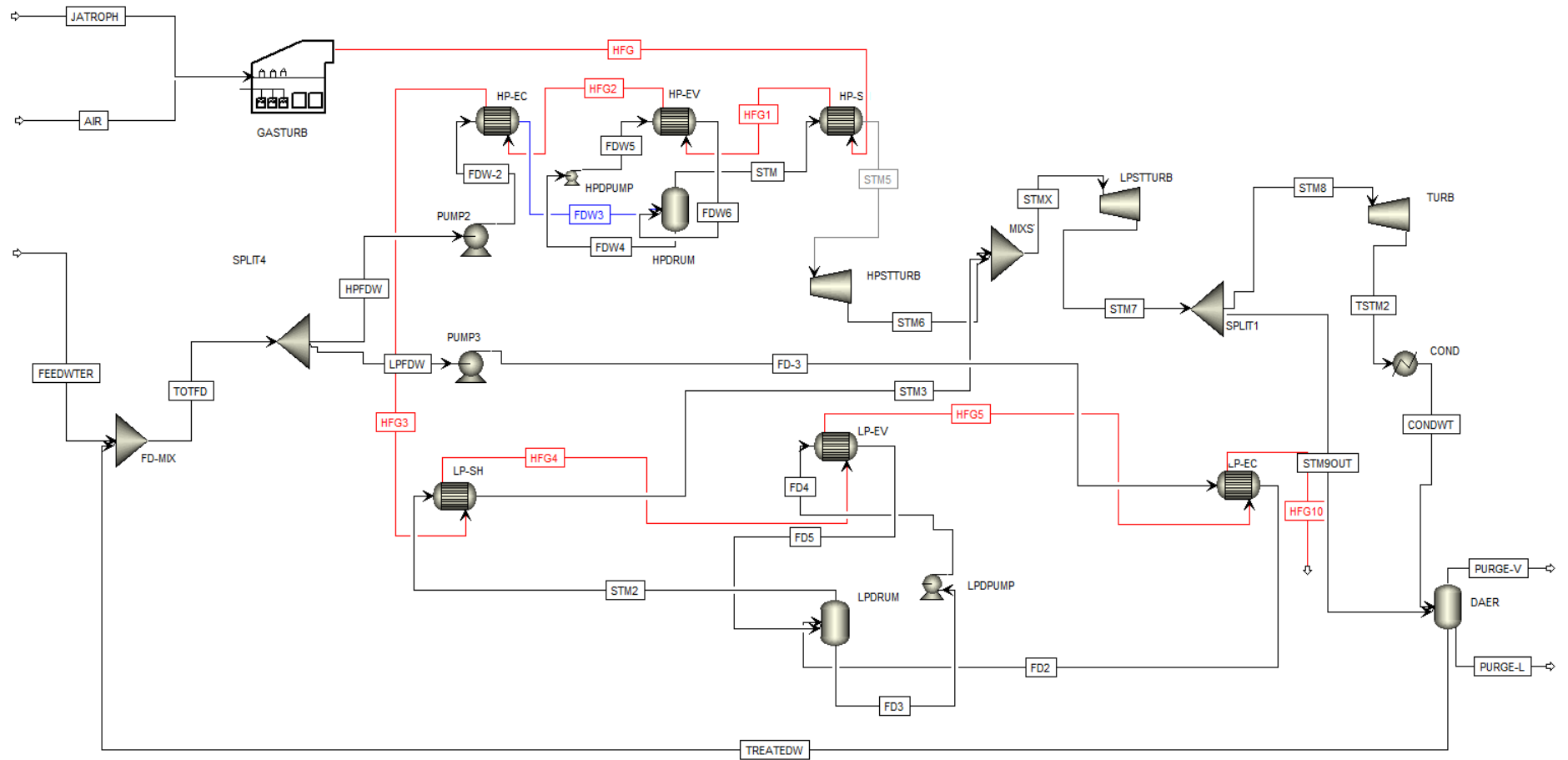

Figure 2: Simplified flow diagram of the combined cycle gas turbine

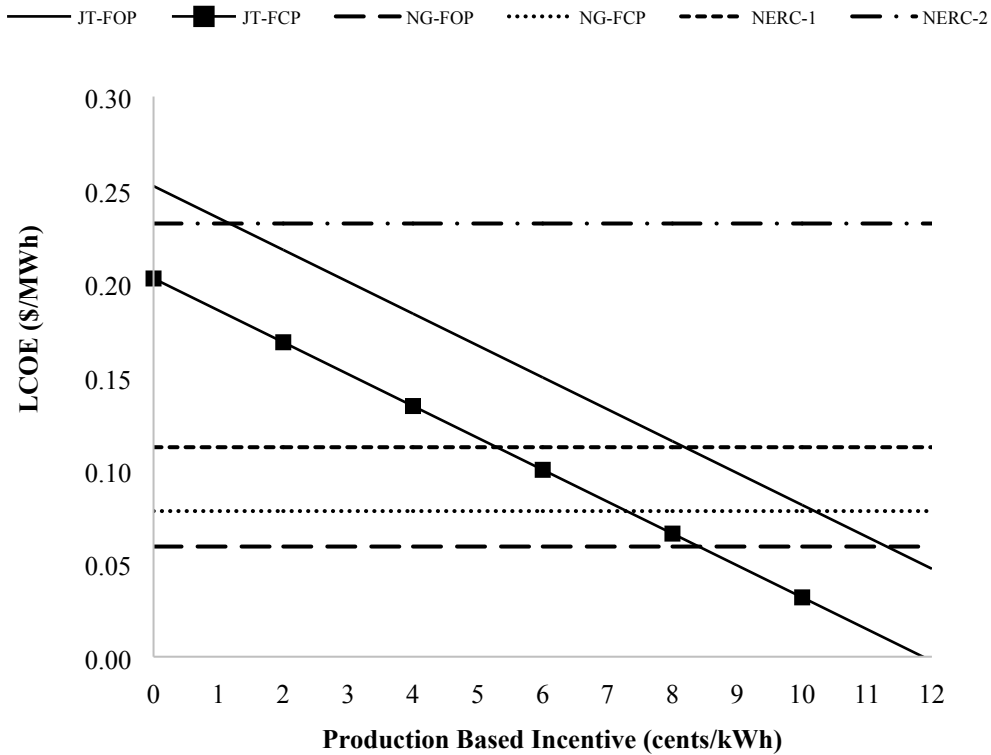

Fig. 3: The LCOE of the Jatropha biodiesel-fired plants with production-based incentive (PBI) support

JT -Jatropha Biodiesel; NG -Natural Gas; -FOP -Fired OCGT Plant; -FCP -Fired CCGT Plant; NERC-1 – Electricity generation price for 2016 new entrants gas power plants; NERC-2 – Electricity generation price for 2016 biomass power plants

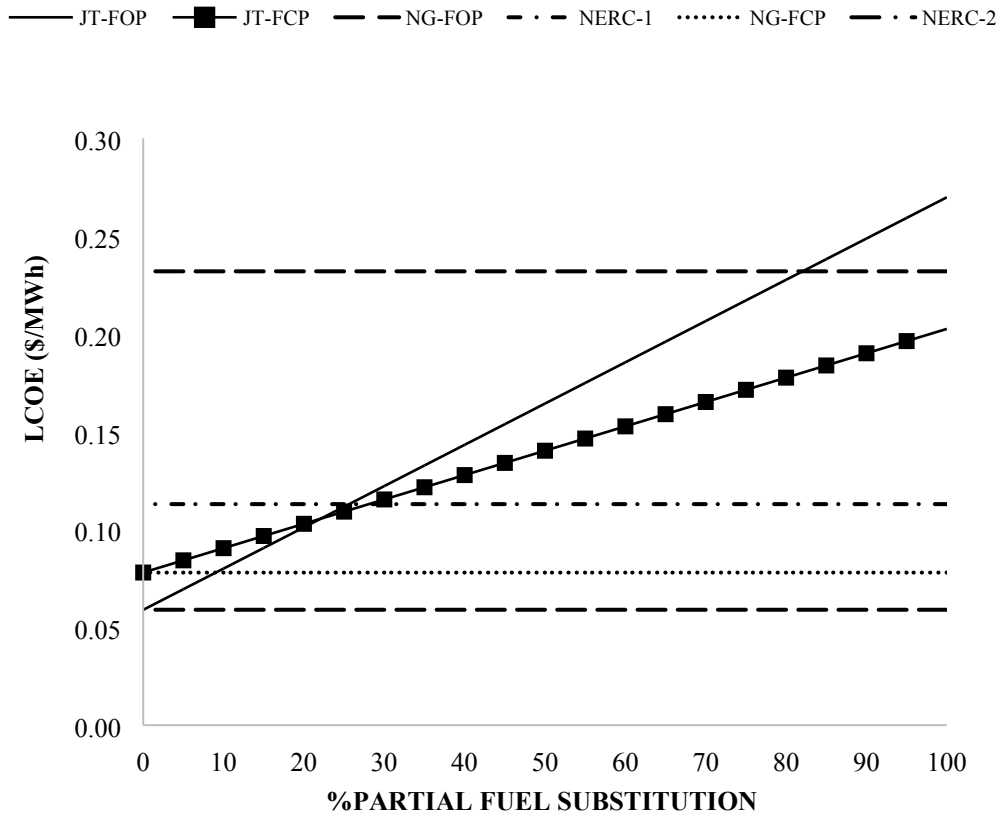

Fig. 4: The LCOE of the natural gas-fired plants with mandatory fuel substitution

JT -Jatropha Biodiesel; NG -Natural Gas; -FOP -Fired OCGT Plant; -FCP -Fired CCGT Plant; NERC-1 – Electricity generation price for 2016 new entrants gas power plants; NERC-2 – Electricity generation price for 2016 biomass power plants

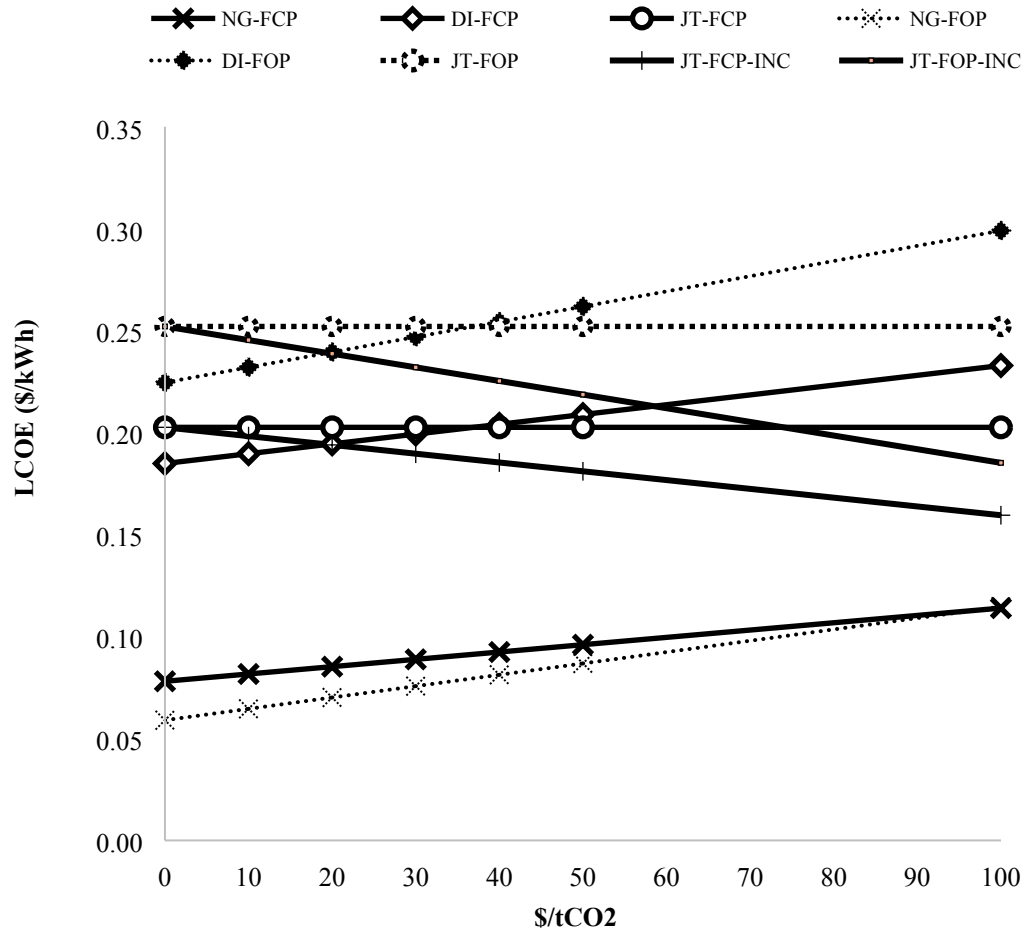

Fig. 5: The LCOE of the natural gas-fired plants with carbon tax levy

JT -Jatropha Biodiesel; NG -Natural Gas; -FOP -Fired OCGT Plant; -FCP -Fired CCGT Plant; INC-Incentivised

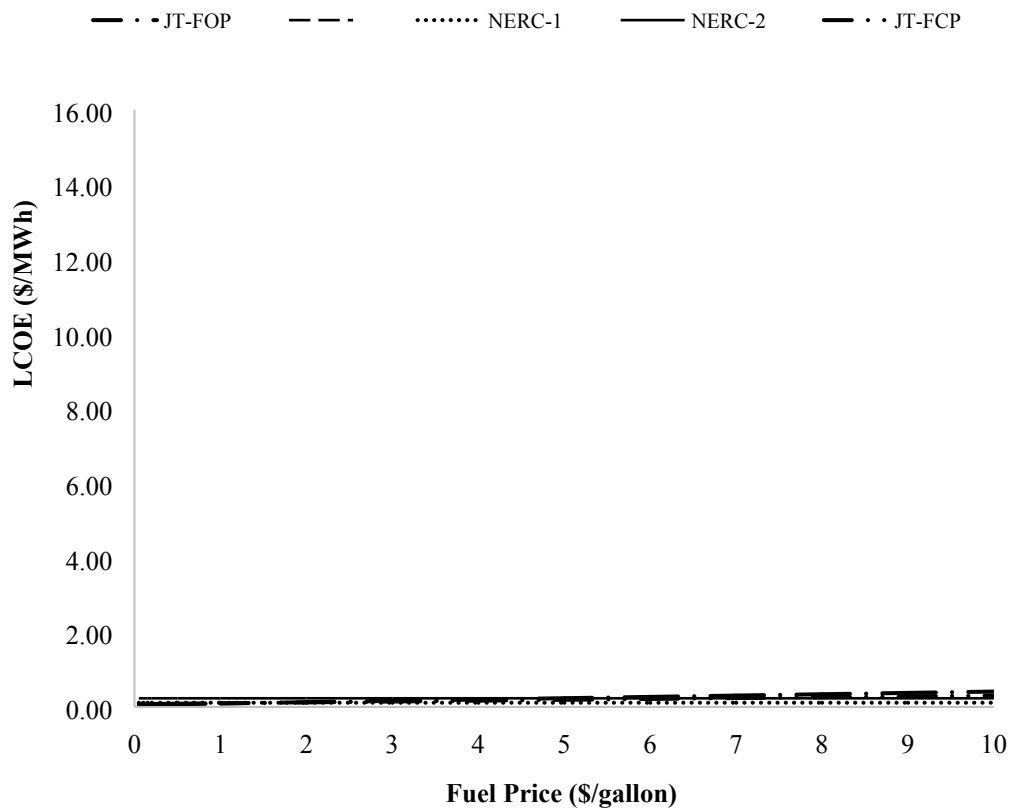

Fig. 6: The LCOE of the *Jatropha* biodiesel-fired plants at varying fuel prices

JT -*Jatropha* Biodiesel; -FOP -Fired OCGT Plant; -FCP -Fired CCGT Plant; NERC-1 – Electricity generation price for 2016 new entrants gas power plants; NERC-2 – Electricity generation price for 2016 biomass power plants

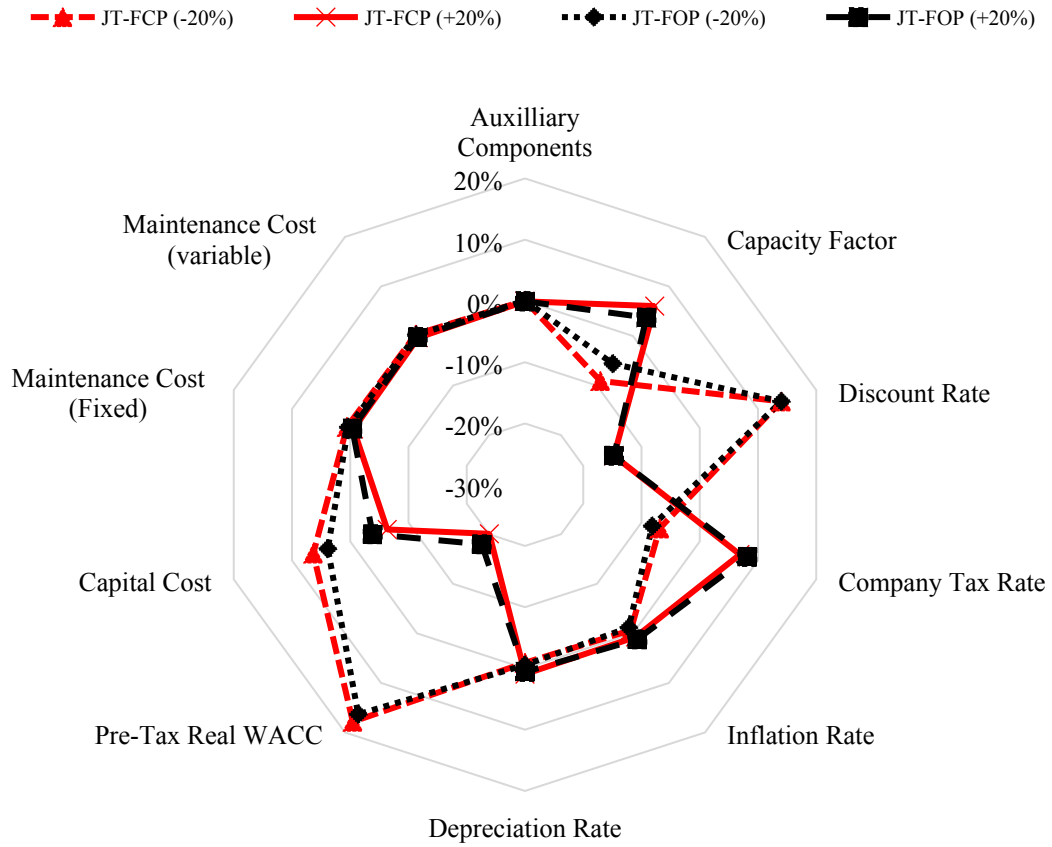

Fig. 7: Sensitivity Analysis on LCOE of the Jatropha biodiesel-fired plants

JT -Jatropha Biodiesel; NG -Natural Gas; -FOP -Fired OCGT Plant; -FCP -Fired CCGT Plant

1 **Highlights**

- 2 • Feasibility of Jatropha biodiesel for power generation in Nigeria was investigated.
- 3 • Application in gas turbines results in ~1-2% loss in plant output and efficiency.
- 4 • The LCOE varied from \$0.203-0.252/kWh, depending on mode of operation.
- 5 • The full cost of self-generated electricity in Nigeria is valued at \$0.45-0.70/kWh.
- 6 • Residents can lower annual energy cost by 71% with Jatropha biodiesel-fired plants.

7

ACCEPTED MANUSCRIPT

Table 1: Input data and model assumptions for the OCGT/Topping cycle

Block Name	Block Parameters & Assumptions
AIRCOMPR (Compressor)	P = 1.013 Bar; T = 15°C; Compressor Isentropic Efficiency = 88%; Pressure Ratio = 12.6; Inlet Mass Flow = 418 kg/s
COMBUST (Combustor)	Combustor Pressure Loss = 5%; Chemical and phase equilibrium calculation; Maximum Combustor Outlet Temperature = 1083°C
TURBINE (Turbine)	Turbine Isentropic Efficiency = 90%; Discharge Pressure = 1.14 Bar

Table 2: Input data and model assumptions for the Bottoming cycle

Block Name	Block Parameters & Assumptions
HP/LP SH (Superheater)	Hot Inlet-Cold Outlet minimum temperature difference = 20°C
HP/LP EC (Economiser)	Cold Outlet Stream Vapor Fraction = 0 (Saturated Liquid)
HP/LV EV (Evaporator)	Cold Outlet Stream Vapor Fraction = 0.5
HPDRUM (Drum)	Discharge Pressure = 80 Bar
LP DRUM (Drum)	Discharge Pressure = 10 Bar
Pump	Pump Efficiency = 80%; Driver Efficiency = 95%
DAER	Inlet Feed Water Temperature = 32.88°C; P = 0.05 Bar
COND	Condenser Pressure = 0.05 Bar
HP/IP/LP STTURB (Steam Turbine)	HP Discharge Pressure = 10 Bar; IP Discharge Pressure = 2 Bar; LP Discharge Pressure = 0.05 Bar; HP Steam Turbine Isentropic Efficiency = 90%; IP Steam Turbine Isentropic Efficiency = 92%; LP Steam Turbine Isentropic Efficiency = 94%; Mechanical Efficiency = 98%; Max. Steam Turbine Inlet Temperature = 560 °C; Minimum approach temperature in economizers, evaporators and superheaters = 5°C; Minimum Steam Quality = 88%; Pressure loss in hot and cold side of the heat exchangers are negligible; Minimum Allowable Stack Temperature = 100 °C

Table 3: Parameters/Properties for the different fuels

Air	Mass fraction (%)	Natural Gas	Mass fraction (%)	Diesel	Mass fraction (%)	Jatropha Biodiesel	Mass fraction (%)
N ₂	0.75550	CH ₄	0.910	H ₂ O	0.00006	JB1- C ₁₂ H ₂₄ O ₂	0.0451
O ₂	0.23160	C ₂ H ₆	0.060	PC87C	0.00001	JB2- C ₁₄ H ₂₈ O ₂	0.0235
AR	0.01240	C ₃ H ₈	0.015	PC101C	0.00002	JB3- C ₁₆ H ₃₂ O ₂	0.1224
CO	0.00000	N ₂	0.008	PC115C	0.00007	JB4- C ₁₈ H ₃₆ O ₂	0.0663
CO ₂	0.00050	O ₂	0.000	PC128C	0.00022	JB5- C ₁₈ H ₃₄ O ₂	0.2351
H ₂ O	0.00000	AR	0.007	PC142C	0.00044	JB6- C ₁₈ H ₃₂ O ₂	0.5076
				PC156C	0.00073		
				PC170C	0.00141		
				PC184C	0.00273		
				PC198C	0.00528		
				PC212C	0.01141		
				PC225C	0.02528		
				PC239C	0.04842		
				PC253C	0.09122		
				PC267C	0.13514		
				PC281C	0.14483		
				PC295C	0.13421		
				PC309C	0.12056		
				PC322C	0.10539		
				PC336C	0.08402		
				PC350C	0.05418		
				PC364C	0.02486		
				PC378C	0.00749		
				PC392C	0.00163		
				PC406C	0.00033		
				PC419C	0.00006		

Table 4: Input in the Economic Model (Base-case)

Parameters	
Plant Life	20 Years
Output Losses	Auxiliary Components -2%; Transmission Losses -11%; Capacity Factor -80%; Capacity Degradation -2%
Economic Rates	Company Tax Rate-32%; Escalation Rate-11%; Depreciation Rate-5%; Exchange Rate-161 (₹/\$); Pre-Tax Real WACC-11%; Discount rate-11%
Cost factor (OCGT)	Capital Cost -\$978.5/MWh; Fixed Maintenance Factor -\$15503/MW/Yr; Variable Maintenance Factor-\$5.6/MWh; Emission Cost -\$0/tCO ₂
Cost factor (CCGT)	Capital Cost -\$1370/MWh; Fixed Maintenance Factor -\$21704/MW/Yr; Variable Maintenance Factor-\$7.9/MWh; Emission Cost -\$0/tCO ₂
Fuel Price	Natural Gas -\$2.8/MMBTU; Jatropha Biodiesel -\$5.5/gallon; Diesel -\$5.5/gallon
Fuel LHV	Natural Gas -49.07 MJ/kg; Jatropha Biodiesel -36.58 MJ/kg; Diesel -42.58 MJ/kg
Data (SME)	Engine rating -80&100 kVA (Perkins 1100 Series/Duetz); Operating hours -10 hrs/day; Power factor -80%; Purchase Cost – (0.0272/kWh); Fuel Cost -0.0766/kWh; Maintenance Cost -0.0053/kWh
Data (Household)	Engine rating -22 kVA; Operating hours -6 hrs/day; Power factor -80%; Purchase Cost – (0.1603/kWh); Fuel Cost -0.3519/kWh; Maintenance Cost -0.0348/kWh

Table 5: Engine Validation of the Natural Gas OCGT and CCGT engines at ISO Conditions

Parameters	PG9171E (MS9001 E)	NG*	Error
OCGT (1 Gas Turbine)			
Output (MW)	126.1	126.8	+0.52%
Heat Rate (kJ/kWh)	10653	10750	+0.91%
Mass Flow (kg/s)	418	419	+0.24%
Exhaust Temperature (°C)	543	545	+0.37%
Thermal Efficiency (%)	34.1	33.5	-1.79%
CCGT (2 Gas Turbines – 1 Steam Turbine)			
Output	391.4	382.5	-2.27%
Heat Rate	6840	7121	+4.01%
Net Plant Efficiency	52.7	50.6	-3.98%

* LHV of Natural gas – 49.07 MJ/kg

Table 6: Technical Analysis of the OCGT and CCGT engines (different fuels) at Site Conditions

Parameters	NG	DI	JT
OCGT (4 Gas Turbines)			
Total Output (MW)	468.8	456.1	460.4
Heat Rate (kJ/kWh)	11066	11283	11172
Thermal Efficiency (%)	32.5	31.9	32.2
Fuel Flow	14.68	16.79	19.53
CCGT (4 Gas Turbines – 2 Steam Turbines)			
Output	726.8	712.1	716.4
Heat Rate	7138	7228	7180
Net Plant Efficiency	50.4	49.8	50.1

Table 7: Economic Analysis of the OCGT and CCGT engines (different fuels) at Site Conditions

Parameters	NG	DI	JT
OCGT (4 Gas Turbines)			
LCOE (\$/MWh)	0.059	0.225	0.252
SPB (Years)	5	>20	>20
NPV (\$'million)	3295	-761	-1614
Benefit-to-Cost Ratio (B/C)	4.45	0	0
CCGT (4 Gas Turbines – 2 Steam Turbines)			
LCOE (\$/MWh)	0.078	0.185	0.203
SPB (Years)	7	16	20
NPV (\$'million)	4868	1039	439
Benefit-to-Cost Ratio (B/C)	3.42	0.15	0.06

Table 8: The Average Cost of Self-Generated Electricity in Nigeria

Parameters		SME	Household
Self-generated Electricity for a 24-hr period	\$/kWh	0.45	0.70
Self-generated Electricity for a defined period*	\$/kWh	0.19	0.46

*self-generated electricity for a period and black-out for the rest of the day.