

Dynamics stiffness enhancement of fast tool servo by acceleration feedback

Fei Ding¹, Xichun Luo^{1*}, Yukui Cai¹

¹Centre for Precision Manufacturing, DMEM, University of Strathclyde, UK

*Corresponding author's email: xichun.luo@strath.ac.uk

Abstract

Fast Tool Servo (FTS) devices are widely used in manufacturing of micro features on large areas. Dynamic stiffness of such devices is usually poor due to their low inertia which cause profile errors. In this paper, a triple feedback scheme is proposed to enhance the dynamic stiffness by introducing acceleration feedback. Position and acceleration signals together with motor current were combined to estimate the cutting force. Then the force is compensated by the controller output. Frequency response tests showed suppressed disturbance response around the cross over frequency. Further face turning experiments demonstrated that the new feedback scheme helped reducing the dynamic errors caused by sudden change of cutting forces.

Keywords: dynamic stiffness, fast tool servo, acceleration feedback

1. Introduction

The demands for freeform optics and roller moulds with lots of micro features are increasing in the optic market. Hard materials like nickel alloy and silicon are commonly seen in these applications. Fast tool servo devices are necessary to cut out the small features efficiently. However, FTS suffers inferior dynamic stiffness to machine tool slides and often results in larger form errors when cutting hard materials.

The inertia of the FTS device cannot be increased in exchange for higher dynamic stiffness due to the drive power limits. Acceleration feedback technique theoretically can improve it [1] but it hasn't been widely used in FTS application. Different concepts with additional acceleration feedback has been proposed and tested on industrial motor [2]. In this paper a new triple feedback control scheme is adopted to control the voice coil motor in pursue of enhancing the dynamic stiffness of the fast tool servo device.

2. Methodology

In the conventional cascade loop control structure shown in Figure 1, the current loop is closed upon a small current sensing resistor in series of motor windings. So that the current

feedback only depicts how much force is generated by the motor. Any disturbances such as cutting force or cable induced force cannot be sensed until they induce errors on the velocity signal or position signal. This means fast response to these disturbances is not feasible.

In the new proposal, accelerometers are used to measure the momentum stage acceleration without the integration delay. The acceleration signal is strictly proportional to the net force including disturbances. Thus the controller can compensate the disturbance force before it affects positioning accuracy, creating a 'virtual mass' effect.

The position, acceleration and motor current signals are simultaneously sampled by the controller and then the cutting force disturbance is estimated. The acceleration signal is used to calculate the total force acting on the tool and the motor output force is deducted from the total force resulting in the disturbances. The estimated disturbance is feedback to the control loop and then compensated by the control output. The outer position loop is closed by PIDF control algorithm.

The red arrows in Figure 2 show the shortest path from outside disturbance to control action. The sensor fusion block is optional.

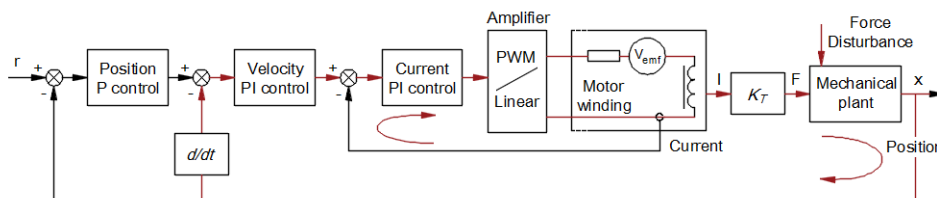

Figure 1. Conventional cascade PID control with single feedback

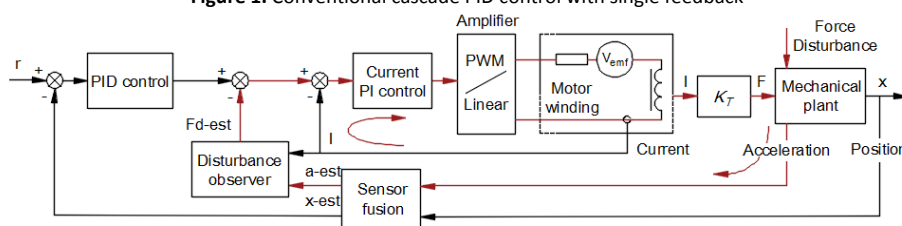

Figure 2. Triple feedback control with acceleration and current measurements

2.1. System setup

A special fast tool servo device is designed as shown in Figure 2. In this design, single phase flat voice coil motor is extended along the X direction to release the motion degree of freedom which is usually constrained in traditional voice coil motor design. Flexure guidance is fixed on the carriage of the X guide slide. The motion along X direction is driven by a linear motor and guided by mechanical linear slide. The inertial force and cutting force are directed to the fixed magnetic track. With no flexible mode prone to be excited by the forces, the dynamic characteristics are made close to that of single body mass-spring-damper system.

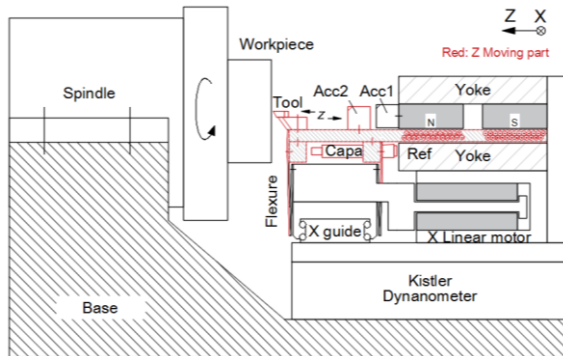

Figure 3. Diagram of the fast tool servo device with accelerometers

The control algorithm is run on custom built board with DSP. The current loop is realised by analogue PI current loop with a closed loop bandwidth of 400 kHz (-3dB). Capacitive displacement sensor (Lion Precision CPL190) is used as the primary position feedback source and two accelerometers (PCB Electronics 333B50) are used to measure the relative acceleration of the cutting tool. The control servo loop is run at 200 kHz rate. The control algorithm is shown in Figure 4 where K_T is the motor force constant and G_{cur} is the current closed loop transfer function. A second order model is used to estimate the total force. This second model has been proved to agree with the experimental frequency response with 94.3% fit up to 10 KHz.

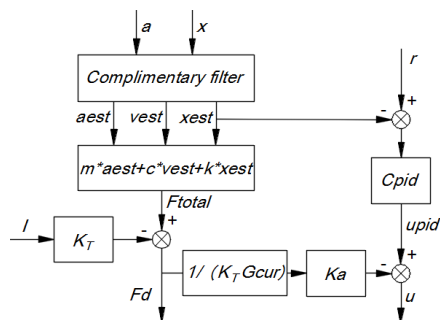

Figure 4. Control algorithm with disturbance observer

2.2. Dynamic stiffness tests

The dynamic stiffness is tested in field by injecting a sweep sinusoidal disturbance voltage onto the control output. Since the current loop bandwidth is high, this disturbance voltage is near proportional to disturbance force. Figure 5 shows the transfer functions from disturbance voltage to position output with same PIDF gains and different acceleration gains. The frequency response is damped by the acceleration feedback and thus the dynamic stiffness at this point is enhanced. What's more, this feedback scheme has been proved to permit higher PID gains without causing closed loop instability.

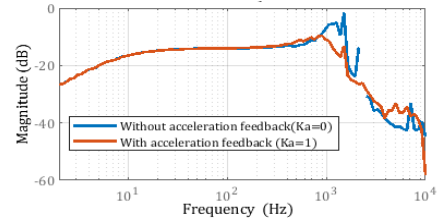

Figure 5. Disturbance rejection transfer functions with/without acceleration feedback

3. Cutting experiments

The FTS device is mounted onto a diamond turning machine with its original slides disabled. Several grooves are made on a copper part. Thus the cutting force will change abruptly during face turning. The depth of cut is 5 μm and the diamond tool radius is 0.5 mm. The feed rate is selected as 300 $\mu\text{m}/\text{rev}$ such that cutting trajectory will not overlap.

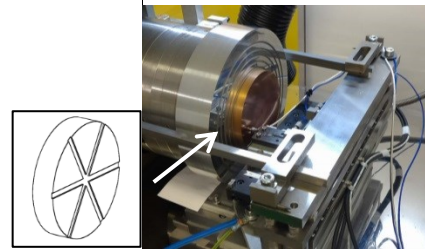

Figure 6. Experimental setup on diamond turning machine

4. Results

The following error and estimated normal force are acquired simultaneously during cutting shown in Figure 7. The sudden change of depth of cut causes large following errors on pure PID control mode, however, this influence is not observable when acceleration signal is used.

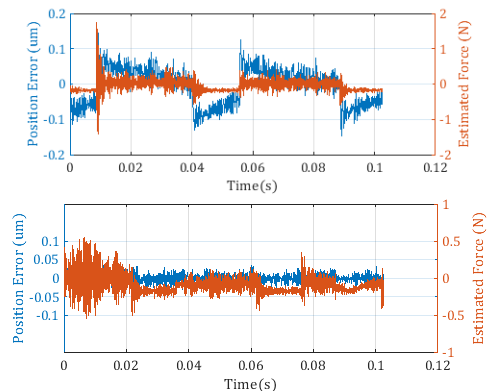

Figure 7. Measured errors and force with/without acc feedback

5. Conclusion

A triple feedback control scheme with acceleration feedback is developed to control a fast tool servo device to enhance its dynamic stiffness. Frequency response test shows improved damping at cross over frequency. Face turning tests shows that the following error caused by sudden change of cutting force has been reduce from 0.1 μm to negligible. This demonstrated the effectiveness of acceleration feedback on improving dynamic stiffness.

References

- [1] R. D. Lorenz, "Design Principles and Implementation of Acceleration Feedback to Improve Performance of dc Drives," *IEEE Trans. Ind. Appl.*, vol. 28, no. 3, pp. 594-599, 1992.
- [2] M. Griese and J. Maas, "Control concepts with acceleration feedback for servo systems," *IEEE/ASME Int. Conf. Adv. Intell. Mechatronics (AIM)*, pp. 816-821, 2016.